

# Standard Operation Procedures for Discrete PM2.5 and PM10 Using the Partisol 2025i

In Use By

**Polk County Air Quality  
Ambient Air Monitoring Personnel**

**For Calendar Year 2023**

**Revised: February 23, 2023**

**Section: 4  
Revision: 9**

**PREPARED BY**

  
\_\_\_\_\_  
*Polk County Air Quality Compliance Technician*

3-2-23  
*Date*

**SIGNATURES/APPROVALS**

  
\_\_\_\_\_  
*Polk County Air Quality Assurance Officer*

3/2/23  
*Date*

POLK COUNTY AIR QUALITY DIVISION

STANDARD OPERATING PROCEDURE MANUAL FOR THERMO FISHCER 2026i PARTICULATE SAMPLER

<b>Table of Contents</b>		<b>Page #</b>
<b>4.1</b>	<b>Purpose.....</b>	<b>3</b>
<b>4.2</b>	<b>Scope.....</b>	<b>3</b>
<b>4.3</b>	<b>References.....</b>	<b>3</b>
<b>4.4</b>	<b>Introduction.....</b>	<b>3</b>
<b>4.5</b>	<b>Health and Safety Warning/Precautions.....</b>	<b>5</b>
<b>4.6</b>	<b>Sampler Set-up.....</b>	<b>6</b>
<b>4.6.1</b>	<b>Inspecting New Equipment.....</b>	<b>6</b>
<b>4.6.2</b>	<b>Setup of New Equipment.....</b>	<b>6</b>
<b>4.6.3</b>	<b>Programming the Sampler.....</b>	<b>7</b>
<b>4.6.3.1</b>	<b>Default Sample Setup.....</b>	<b>8</b>
<b>4.6.3.2</b>	<b>Basic Sampling Method.....</b>	<b>8</b>
<b>4.6.3.3</b>	<b>Default Sample Times.....</b>	<b>8</b>
<b>4.6.3.4</b>	<b>System Setup.....</b>	<b>8</b>
<b>4.6.3.5</b>	<b>Flow Calibration Setup.....</b>	<b>9</b>
<b>4.6.3.6</b>	<b>Data Logging.....</b>	<b>9</b>
<b>4.6.3.7</b>	<b>Site ID.....</b>	<b>9</b>
<b>4.6.3.8</b>	<b>Communications.....</b>	<b>9</b>
<b>4.6.3.9</b>	<b>AK Setup.....</b>	<b>10</b>
<b>4.6.3.10</b>	<b>USB Setup.....</b>	<b>10</b>
<b>4.6.3.11</b>	<b>Date/Time.....</b>	<b>10</b>
<b>4.6.3.12</b>	<b>Timezone.....</b>	<b>10</b>
<b>4.6.3.13</b>	<b>Password.....</b>	<b>10</b>
<b>4.6.3.14</b>	<b>Restore User Defaults.....</b>	<b>10</b>
<b>4.7</b>	<b>Standards .....</b>	<b>10</b>
<b>4.7.1</b>	<b>Transfer Standards .....</b>	<b>10</b>
<b>4.7.2</b>	<b>Audit Standards.....</b>	<b>10</b>
<b>4.7.3</b>	<b>Qualification, Certification and Recertification.....</b>	<b>11</b>
<b>4.8</b>	<b>Quality Control.....</b>	<b>11</b>
<b>4.8.1</b>	<b>Station Inspection.....</b>	<b>11</b>
<b>4.8.2</b>	<b>Station Log Book.....</b>	<b>12</b>
<b>4.9</b>	<b>Equipment, Maintenance and Trouble Isolation.....</b>	<b>12</b>
<b>4.9.1</b>	<b>The Monitoring Station.....</b>	<b>12</b>
<b>4.9.2</b>	<b>Preventative Maintenance.....</b>	<b>12</b>
<b>4.9.2.1</b>	<b>Cleaning Air Intake Filters.....</b>	<b>12</b>
<b>4.9.2.2</b>	<b>Inspect “V” Seals.....</b>	<b>12</b>
<b>4.9.2.3</b>	<b>Pump.....</b>	<b>13</b>
<b>4.9.2.4</b>	<b>Software Update.....</b>	<b>13</b>
<b>4.9.3</b>	<b>Trouble Isolation.....</b>	<b>13</b>
<b>4.10</b>	<b>Quality Assurance (Accuracy –Audits).....</b>	<b>14</b>
<b>4.11</b>	<b>Data Quality Assessment.....</b>	<b>15</b>
<b>4.11.1</b>	<b>Precision.....</b>	<b>15</b>
<b>4.11.2</b>	<b>Accuracy.....</b>	<b>15</b>
<b>4.11.3</b>	<b>Data Completeness.....</b>	<b>15</b>
<b>4.12</b>	<b>Calibrations.....</b>	<b>15</b>
<b>4.12.1</b>	<b>Temperature Calibration.....</b>	<b>15</b>
<b>4.12.1.1</b>	<b>Calibration of Ambient and Filter Temperature Sensors.....</b>	<b>15</b>
<b>4.12.1.2</b>	<b>Calibration of Filter Compartment Temperature Sensor.....</b>	<b>17</b>
<b>4.12.1.3</b>	<b>Calculations.....</b>	<b>17</b>
<b>4.12.2</b>	<b>Pressure Calibration.....</b>	<b>17</b>
<b>4.12.2.1</b>	<b>Calibration Procedures .....</b>	<b>17</b>
<b>4.12.2.2</b>	<b>Calculations .....</b>	<b>18</b>

**Section 4: Discrete PM2.5 and PM10**

Revised: February 23, 2023

Revision Number: 9

- 4.12.3 Flow Calibration..... 18
  - 4.12.3.1 Calibration Procedures..... 18
  - 4.12.3.2 Calculations..... 20
- 4.13 Sampler Operations..... 20
  - 4.13.1 Quality Control.....20
    - 4.13.1.1 Ambient, Filter, and Filter Compartment Temperatures.....20
    - 4.13.1.2 Ambient Pressure..... 20
    - 4.13.1.3 External Leak Check..... 21
    - 4.13.1.4 Internal Leak Check..... 21
    - 4.13.1.5 Flow Rate Verification..... 21
    - 4.13.1.6 Maintenance..... 21
  - 4.13.2 Procedures..... 22
  - 4.13.3 Maintenance of the Very Sharp Cut Cyclone (VSCC)..... 23
  - 4.13.4 Pre-Sampling Verification.....23
    - 4.13.4.1 Temperature, Pressure and Flow Verifications.....25
    - 4.13.4.2 Maintenance of the Top Acceleration Assembly.....26
    - 4.13.4.3 Maintenance of the Lower Collector Assembly.....27
    - 4.13.4.4 Reassemble and Reinstallation of Inlet.....27
  - 4.13.5 Programming the Sampler..... 27
  - 4.13.6 Post-Sampling Verification and Data Retrieval..... 28
- 4.14 Validation and Reporting of Data..... 29
  - 4.14.1 Calculation Validation..... 29
  - 4.14.2 Final Data Validation.....29
  - 4.14.3 Data Reporting..... 29

**FIGURES**

- Figure 4-1: Very Sharp Cut Cyclone (VSCC) used for PM2.5 Sampling..... 4
- Figure 4-2: Exploded Cross-Sectional View of Inlet Head Common to Both PM2.5 and PM10 Samplers..... 5
- Figure 4-3: Schematic Drawing of the Air Flow Through a Very Sharp Cut Cyclone..... 24

**TABLES**

- Table 4-1: Audit Activities and Acceptance Criteria.....14
- Table 4-2: Calibration, Verification, and Maintenance Check Intervals..... 22
- Table 4-3: Measurement Quality Objectives.....30
- Appendix A-Critical Forms and Field Sheets..... 36

## **4.0 STANDARD OPERATING PROCEDURE FOR DISCRETE PM2.5 and PM10 MONITORING USING THE THERMO SCIENTIFIC 2025i SEQUENTIAL AIR SAMPLER**

### **4.1 Purpose**

To establish a standard operating procedure (SOP) for Polk County Ambient Air Quality personnel to ensure proper set-up and installation of the Thermo Scientific Model 2025i Sequential Air Sampler.

### **4.2 Scope**

These procedures are to be used by Polk County Air Quality Division personnel. The objective of this SOP is to familiarize the station operator with procedures used in the collection of air monitoring data. The accuracy of data obtained from any instrument depends upon the instrument's performance and the operator's skill. It is important that the station operator become familiar with both this SOP as well as the manufacturer's instruction manual in order to achieve a high level of data quality. This SOP is to be used as an outline and is not intended to replace the equipment manufacturer's manual or procedures.

### **4.3 References**

- 4.3.1 Partisol®-2025i Sequential Air Sampler Instruction Manual, Thermo Scientific, April 14, 2015.**
- 4.3.2 Partisol®-2025i Sequential Air Sampler Quick Start Guide PM-2.5 Sampling Setup. Thermo Scientific, April 14, 2015.**
- 4.3.3 Partisol®-2025i Sequential Air Sampler Quick Start Guide PM-10 Sampling Setup. Thermo Scientific, April 14, 2015.**
- 4.3.4 40 Code of Federal Regulations (CFR) Part 50, Appendix L, Reference Method for the Determination of Particulate Matter as PM2.5 in the Atmosphere.**
- 4.3.5 40 Code of Federal Regulations (CFR) Part 50, Appendix M, Reference Method for the Determination of Particulate Matter as PM10 in the Atmosphere.**
- 4.3.6 40 Code of Federal Regulations (CFR) Part 58, Appendix A, Quality Assurance Requirements for State and Local Air Monitoring Stations (SLAMS).**
- 4.3.7 EPA-454/B-16-001 Quality Assurance Guidance Document 2.12, Monitoring PM2.5 in Ambient Air Using Designated Reference or Class I Equivalent Methods, USEPA, January 2016. (<https://www3.epa.gov/ttnamti1/files/ambient/pm25/qa/m212.pdf>).**
- 4.3.8 PM2.5 Mass Validation Criteria, March 30, 1999. (<https://www3.epa.gov/ttnamti1/files/ambient/pm25/qa/valdtmpl.pdf>).**
- 4.3.9 Quality Assurance Handbook for Air Pollution Measurement Systems, Volume II, Ambient Air Quality Monitoring Program, Appendix D. Revision 1, March, 2017.**

### **4.4 Introduction**

This document describes the procedures used to sample PM2.5 and PM10 particulate matter by the Polk County Air Quality Program. PM2.5 has an aerodynamic diameter of 2.5 micrometers or less, while PM10 has an aerodynamic diameter of 10 micrometers or less.

For PM2.5 sampling, a Partisol®–2025i Sequential Air Sampler draws a known volume of ambient air at a constant flow rate through a PM10 size-selective inlet followed by a Very Sharp Cut Cyclone (VSCC) particle size separator. Figure 4-1 displays the VSCC which removes particles in the 2.5 to 10

## Section 4: Discrete PM2.5 and PM10

Revised: February 23, 2023

Revision Number: 9

micrometer range. Particles in the PM2.5 size range are then collected on a Teflon® filter during a specified 24-hour sampling period. Each sample filter is weighed before and after sampling to determine the net weight (mass) gain of the collected PM2.5 sample. This mass concentration is reported as micrograms per cubic meter at local conditions. The reference method for PM2.5 sampling is given in the Code of Federal Regulations (40 CFR 50, Appendix L). This document is intended to be used together with the sampler-specific information and instructions provided by the manufacturer of the PM2.5 sampler in the sampler's operation or instruction manual.

For PM10 sampling, a Partisol®–2025*i* Sequential Air Sampler can also be used. The Very Sharp Cut Cyclone is removed and replaced with a pass through adapter tube. Particles in the PM10 size range are then collected on a Teflon® filter during a specified 24-hour sampling period. Each sample filter is weighed before and after sampling to determine the net weight (mass) gain of the collected PM10 sample. This mass concentration is reported as micrograms per cubic meter at standard conditions (25°C and 760 mmHg). The two different configurations of Set Temp/Flow Screens are shown later in this SOP to reflect the difference between reporting PM2.5 at local conditions and PM10 at EPA standard conditions (Section 4.5.3.4). The reference method for PM10 sampling is given in the Code of Federal Regulations (40 CFR 50, Appendix M).

Figure 4-2 is a schematic drawing showing the inlet head of the PM2.5 and PM10 samplers. The inlet is designed to remove particles with aerodynamic diameter greater than 10 µm and to send the remaining smaller particles to the next stage. The design flow rate through the inlet is 16.7 liters per minute.

**Figure 4-1: Very Sharp Cut Cyclone (VSCC) Used for PM2.5 Sampling**



Figure 4-2: Exploded Cross-Sectional View of Inlet Head Common to Both PM2.5 and PM10 Samplers

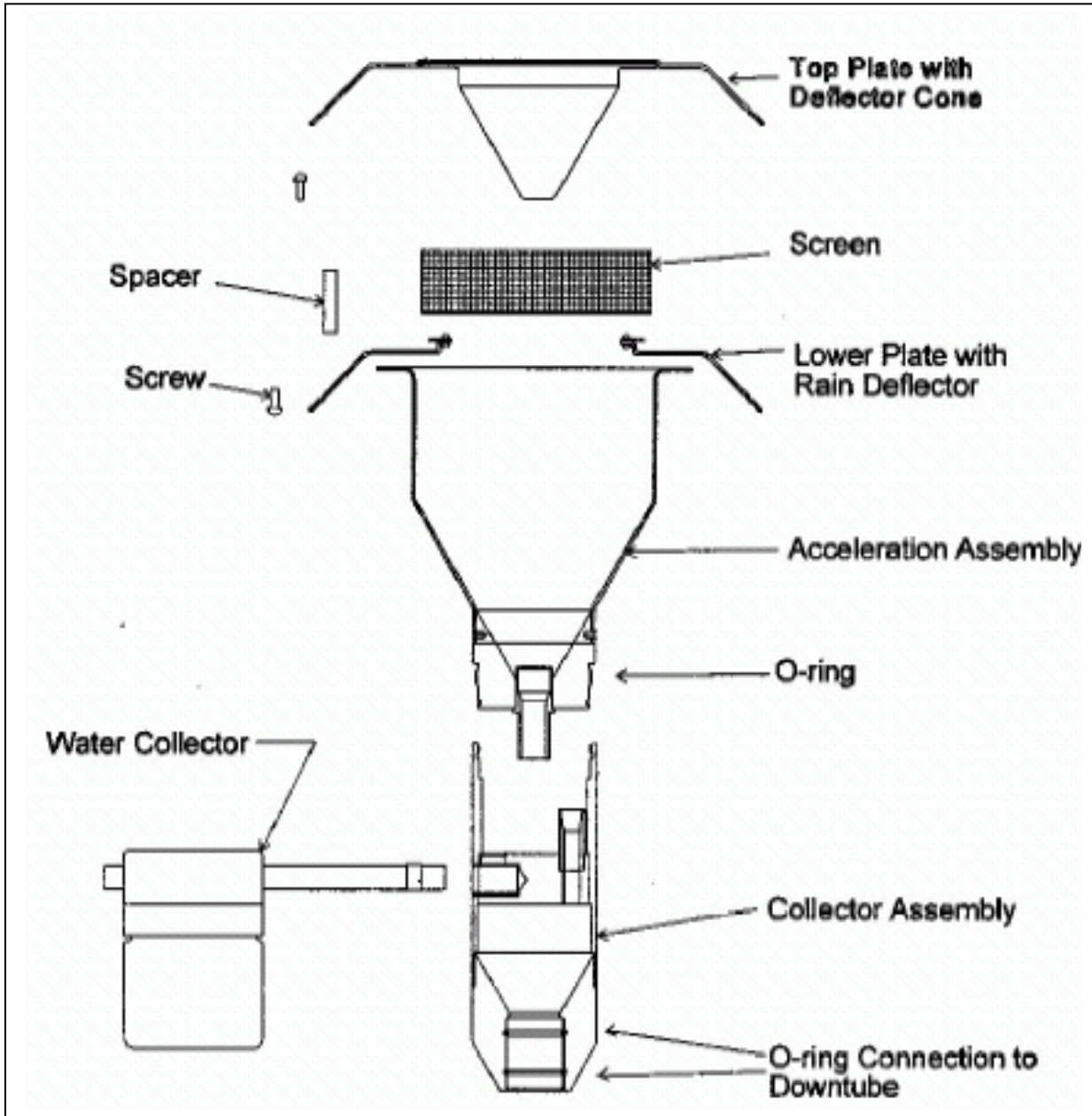

#### 4.5 Health and Safety Warning/Precautions

Only properly trained personnel should perform 2025i testing, installation, operation, maintenance and calibration procedures. As with all monitoring equipment, precautions should be taken when working around electricity, power tools and above ground elevations.

## **4.6 Sampler Setup**

### **4.6.1 Inspecting New Equipment**

When shipment of the sampler is received, verify that the package contents are complete as ordered. Inspect the instrument for external physical damage due to shipping, such as scratched or dented panel surfaces and broken knobs or connectors.

Remove the instrument cover and all interior foam packing and save (in case future shipments of the instrumentation are needed). Make note of how the foam packing was installed.

Inspect the interior of the instrument for damage, such as broken components or loose circuit boards. Make sure that all of the circuit boards are completely secured. (Loose boards could short out the motherboard). If no damage is evident, the monitor is ready for calibration, installation and operation. If any damage due to shipping is observed contact Thermo Scientific at 1-866-282-0430 for instructions on how to proceed.

If you discover that the instrument was damaged during shipping and it becomes necessary to return it to the manufacturer, repack it in the same way it was delivered.

### **4.6.2 Setup of New Equipment**

The sampler should arrive in two parcels. A large rectangular box contains the sampler and its accessories. A cylindrical tube contains the stand. A flat blade screwdriver, a #2 Phillips screw driver and a 7/16" wrench are necessary for assembly. Materials needed for other aspects of the setup are listed in the relevant SOP document.

Begin a logbook or logbook section for the sampler.

Unpack the sampler and check the components against the list above and the packing list enclosed with the sampler. Record the sampler serial number in the logbook.

Cut any tie wraps and remove any transport restraints from inside the sampler enclosure. Assemble the Partisol® Stand and mount the sampler enclosure on the stand with the hardware provided.

Install the large rain hood on the right side of the enclosure. The rain hood should cover both air filters:

- Peel back the paper facing of the larger gasket and apply it to the larger rain hood.
- Place the large rain hood with its gasket attached on the enclosure.
- Secure the rain hood to the unit using four (4) #10-32 x 1/2" slot bind head screws.
- Install the two small rain hoods. Both rain hoods are installed on the back panel of the enclosure.
- Peel back the paper facing of one of the smaller gaskets and apply it to one of the smaller rain hoods.
- Place the small rain hood with its gasket attached on the enclosure.
- Secure the rain hood to the unit using four (4) #10-32 x 1/2" slot bind head screws.
- Repeat this procedure for the other small rain hood.

Install the sample tube and 1<sup>st</sup> stage inlet:

- Insert the end of the sampler tube with the 5cm (2 inch) machined section into the bulkhead of the sampler. Ensure that the tube is pushed into the enclosure through the final O-ring unit it hits a stop.
- Turn the dome connector on the bulkhead to ensure a tight grip.
- Place the 1<sup>st</sup> stage inlet on the end with 3 cm (1.25 inch) of machining. Ensure that the tube is pushed past the inlet's two O-rings, which provide some resistance, and hits a stop.

Install the ambient temperature sensor:

- Locate the two screws installed on the left side of the enclosure.
- Remove the two screws, being careful not to lose the washers. This will expose two holes.
- Locate the ambient temperature probe assembly in the compilation package.
- Place the ambient temperature probe assembly over the two holes in the left side of the sampler enclosure.
- Secure the assembly to the enclosure using the screws and washers previously removed. Place the washers between the ambient temperature bracket and the enclosure (not under the head of the screw) to prevent leakage of water into the electronics compartment.
- Plug the ambient temperature probe into the connector on the back panel of the sampler labeled "Ambient Temperature".

Loading and installing a cassette magazine:

- Load the supply magazine with assembled filter cassettes, so that the filters are facing the open end of the supply magazine.
- Install the loaded supply magazine (air connection facing the operator) in the left side of the sampler.
- Attach the air pressure supply tube at the base of the supply cassette magazine.
- Install the empty supply magazine in the right side of the sampler.
- Connect the unit to the electric supply.

For more detailed information concerning setup of the 2025*i*, refer to Partisol®-2025*i* Sequential Air Sampler Quick Start Guide PM-2.5 Sampling Setup and Partisol®-2025*i* Sequential Air Sampler Quick Start Guide PM-10 Sampling Setup.



#### **4.6.3 Programming the Sampler**

Setup screens set the global default sampling parameters for the numerous programming options available. The default sample setup and default sample times screens allow the user to set default sampling parameters. The System Setup screen defines whether the Sampler uses the default Ambient Temperature and Pressure settings, or Standard Temperature and Pressure settings for maintaining and reporting flow rates in volumetric (FRM PM2.5) or standard (FEM PM10) terms. The current standard time and date are also set in the Instrument Setup screens.



#### 4.6.3.1 Default Sample Setup

The Default Sample Setup screen allows the user to define global settings such as the sample definition method (default programming method), the default sample start time and duration, the default repeat time and filter type and the default sample flow rate.

To access the Default Sample Setup menu, press  repeatedly to display the Main Menu, scroll to Instrument Setup and press . Scroll to Default Sample Setup and press .

Setup the instrument default sampling parameters by entering the Default Sample setup screen. The following fields make up the default Sample Setup screen.

Method: Basic  
Flow: 16.7  
Filter Type: (blank)  
Separator: No

#### 4.6.3.2 Basic Sampling Method

There are five sampling methods to choose from: Basic, Time, Time 2, Advanced, and Episodic Sample Method. Polk County uses Basic Sample Method. For a more detailed overview of the four other methods not used by Polk County refer to Partisol®-2025i Sequential Air Sampler Instruction Manual.

#### 4.6.3.3 Default Sample Times

The Default Sample Times screen allows the user to define Start Times, Sample Duration and Repeat Sample Time. Set up the default sampling times.

Start Time: 00:00  
Duration: 24h 00m  
Repeat Time: 24h 00m as the default sample repeat time for every day sampling  
72h 00m as the default setting for 1/3 day sampling  
144h 00m as the default setting for 1/6 day sampling



#### 4.6.3.4 System Setup

The System Setup screen defines whether the Sampler uses the default Ambient Temperature and Pressure settings, or Standard Temperature and Pressure settings for maintaining and reporting flow rates in volumetric (FRM PM2.5) or standard (FEM PM10) terms. Setup the default settings

Avg Temperature: 99.0  
Std Temperature: 25.0  
Avg Pressure: 999  
Std Pressure: 760  
Report Volume: Actual for PM 2.5 sampling  
Standard For PM 10 sampling  
Filter Fan: Automatic

Auto Run: Off  
Flow Error Mode: ERR

**4.6.3.5 Flow Calibration Set Up**

The Flow Calibration Set Up allows the user to define the set flow points and the Constants from the FTS or flow device. Scroll to Flow Calibration Setup and press . Use the arrow keys to choose Flow and press . This puts you in the Cal Setup Flow screen. Use the arrow keys to set the following:

Set point 1	15.000
Set Point 2	16.670
Set Point 3	18.400
No. of Cal points	3
Reset Cal Flow	
FTS Constant M	--.-----
FTS Constant B	--.-----





Also in the Flow Calibration Set Up menu is Use FTS Flow Constants. Hit the  button so that the displayed value for this is YES.

**4.6.3.6 Data Logging**

At this time Polk County does not make any adjustments to the default settings of the Data logging.

**4.6.3.7 Site ID**

The Site ID information has two 32-character fields. The user can enter site identification numbers using one or both fields. If no entry is made in these fields then no site identification numbers will appear in the Sampler’s data output from this screen. Setup the Site ID as follows:

Scroll to Instrument Setup and press . Use the arrow keys to choose Site ID and press . Use the arrow keys to choose ID and press . Enter the AQS Site ID and POC (01 or 02) press . Scroll to ID2 press . Enter the five letter sampler ID, blank space then PM25VSCC for FRM 2.5 samplers and PM10 for FEM PM10 samplers.

FRM PM 2.5 Example:  
ID: 19153251001  
ID2: 20455 PM25VSCC

FEM PM 10 Example:  
ID: 19153251001  
ID2: 20455 PM10

**4.6.3.8 Communications**

The Communications Settings menu is used for communications control and configuration. At this time Polk County does not plan to make any adjustments to the default settings of the Communications.

#### **4.6.3.9 AK Setup**

AK Protocol commands are used to remotely control a Partisol 2025*i* and using a host device such as a PC or a datalogger. At this time Polk County does not plan to make any adjustments to the default settings of the AK protocol.

#### **4.6.3.10 USB Setup**

The USB Setup menu is used to configure removable USB devices to export data logs and audit history to a USB memory device, backup and restore the configuration, update the firmware from a file on a USB memory device, and format the USB drive used. At this time Polk County does not plan to make any adjustments to the default settings of the USB setup.

#### **4.6.3.11 Date/Time**

This allows the user to setup the current date and time(or other standard time selected by the user). Defaults for date and time are:

Date: yyyy/mm/dd

Time: hh:mm

#### **4.6.3.12 Timezone**

The Time zone for Timeserver screen is used to set the time zone. To use the time zone feature, the unit must first be set to the proper time in UTC time. Once this is done the proper time zone is selected (CST GMT +6). Cycle power on the unit for the time zone to take effect.

#### **4.6.3.13 Password**

The Partisol 2025*i* can be locked using a password setup by the user. At this time Polk County does not use a password lock on the 2025*i*.

#### **4.6.3.14 Restore User Defaults**

The Restore Defaults screen is used to reset the user calibration and configuration values to defaults.

## **4.7 Standards**

### **4.7.1 Transfer Standards**

Transfer standards are used to calibrate the station "field" samplers and to perform verifications. Instruments designated as transfer standards are used so the primary standard can remain at a fixed laboratory location where conditions can be carefully controlled and damage to the instrument minimized. Transfer standards are calibrated against the higher-level, primary standards. All transfer standards must be accompanied by the following:

- The manufacturer's manuals for the instruments
- A logbook including a complete chronological record of all certification and recertification data as well as all PM2.5 and PM10 sampler calibrations carried out with the transfer standard

- A complete listing and description of all equipment, materials, and supplies necessary or incidental to the use of the transfer standard
- A complete and detailed operational procedure for using the transfer standard, including all operational steps, specifications and quality control checks

#### **4.7.2 Audit Standards**

Audit standards are used to challenge the station "field" sampler and to perform accuracy checks on a quarterly basis. Audit standards are calibrated against the higher-level, primary standards. All audit standards must be accompanied by the following:

- The manufacturer's manuals for the instruments
- A logbook including a complete chronological record of all certification and recertification data as well as all PM2.5 and PM10 sampler audits carried out with the audit standard
- A complete listing and description of all equipment, materials, and supplies necessary or incidental to the use of the audit standard
- A complete and detailed operational procedure for using the audit standard, including all operational steps, specifications and quality control checks

#### **4.7.3 Qualification, Certification and Recertification**

Qualification consists of demonstrating that the transfer and audit standards are sufficiently stable (repeatable) to be useful as a transfer standard. Repeatability is necessary over a range of variables such as temperature, line voltage, barometric pressure, elapsed time, operator adjustments, or other conditions, any of which may be encountered during use of the transfer standard. After a transfer and audit standard has been shown to meet the qualification requirements, certification is required before it can be used.

### **4.8 Quality Control**

#### **4.8.1 Station Inspection**

Before entering the station, the perimeter should be inspected for damage. Extreme weather conditions, neglect of station maintenance or vandalism that may have resulted in damage to the site since the operator's last visit.

Once the operator has approached the site, she/he should first:

- Check for any obvious sampler malfunctions. For example, check to see that the equipment is running, the pumps are operating and the instrument is cycling properly.
- Note any unusual odors or noise. An unusual odor may indicate a point source of a pollutant or a strange new noise can indicate a malfunction in the equipment. These observations should be recorded in the station log book and may prove to be invaluable if the data is challenged.

The station operator is responsible for making several observations during the station inspection. Any of the above described observation must be thoroughly detailed in the site log book.

#### **4.8.2 Station Log Book**

A station log book must be maintained at each monitoring site and should accurately reflect site operations. The log book will be identified with the station name, station number, date, time, operator, instrument identification, parameter, scale and units. All entries shall include the date, time, maintenance on equipment, and equipment changes. Additional information should include: maintenance performed on the station, abnormal traffic patterns, or nearby construction.

Should the data be challenged, the information recorded in the log book is invaluable. A written record of observations concerning abnormal operations or localized occurrences is critical if a violation of ambient air standards were recorded during this period. Completed log books should be maintained by Polk County Air Quality and will be archived for future reference.

#### **4.9 Equipment, Maintenance and Trouble Isolation**

There are several routine duties that must be performed each time an air monitoring station is inspected. These duties include equipment inspection, performing calibrations, assisting during audits, documentation, and making necessary adjustments or repairs to the instruments.

##### **4.9.1 The Monitoring Shelter**

It is the operator's responsibility to maintain the monitoring station. Routine maintenance includes keeping site clean and being observant of potential problems. Examples of potential problems include:

- Accumulation of dirt and debris
- Infestation by rodents or insects
- Overgrowth of vegetation around the site

##### **4.9.2 Preventative Maintenance**

Each instrument must be periodically examined and serviced to anticipate and prevent instrument failure. Scheduled maintenance on the instruments will prevent costly repairs and loss of data. The routine maintenance required on the samplers by the station operator is minimal and is outlined in the manufacturer's manual. By keeping track of the instruments' responses from week to week, trends can be observed which would alert the operator of a potential problem, and to correct the situation before the instrument fails. Some minor but critical maintenance procedures are as follows:

###### **4.9.2.1 Cleaning Air Intake Filters**

The two filters – one in the filter compartment and one in the pump compartment, should be cleaned at least every month. It is Polk County's procedure to clean both filters monthly, during verifications.

Locate the two air-intake fans. Each of these has an associated air intake filter. Snap off the covers enclosing the air intake filters. Take out the filters and clean them with a brush or wash them with a mild soap solution and water. If the filters were washed in the liquid solution, shake the filters and allow them to dry. Reinstall the filters in their holders and remount the covers.

###### **4.9.2.2 Inspect "V" Seals**

The “V” seals should be inspected and replaced if necessary at least once every three months. Section 10-16 in the Partisol®-2025i Sequential Air Sampler Instruction Manual, Thermo Scientific, April 15, 2015.

Ensure the instrument is in the STOP mode. Unlatch and open the top cover of the 2025i with the down tube and PM10 inlet attached to gain access to the VSCC or down tube. Lift the VSCC or down tube out of the upper part of the sampler enclosure and locate the down tube mount on the top cover. While supporting the ring on the underside of the top cover, remove the four screws that secure the down tube mount to the top cover. Remove the down tube mount and ring. Locate the down tube mount “V” seal. Examine seal for drying and/or cracking. Replace, if necessary. Replace the down tube mount and ring onto the top cover ensuring that the side of the ring with the chamber is facing down.

Locate the top head mounting plate. Remove the 4 thumbscrews that secure the top head mounting plate to the filter exchange assembly. Lift the plate and remove from the enclosure. Locate the two “V” Seals now exposed. The top seal is located in the top head. The bottom seal is located in the now exposed section of the filter exchange assembly. Examine both seals for drying/cracking. Replace, if necessary. Locate the exit cylinder. Remove the three screws that secure the exit cylinder base to the filter exchange assembly. Remove assembly from enclosure. Locate the exit cylinder “V” seal and examine the seal for drying/cracking. Replace, if necessary.

Place the exit cylinder base in its’ proper position on the filter exchange assemble and secure using the three screws. Replace the top head mounting plate and secure using the four thumbscrews. Replace the down tube and close the top cover.

Perform an external leak test and an internal leak test according to the procedure outlined in this manual. Resume normal operation.

#### **4.9.2.3 Pump**

It is recommended that pumps be rebuilt or replaced in all site samplers annually, whether necessary or not. The pump should maintain a minimum pressure of 40 psi (46-48 psi is preferred). Ideally, pumps will be serviced in the fall, so they will operate at maximum efficiency throughout the winter. Pumps may be rebuilt, but should be replaced after several rebuilds. Wipe down the interior of the sampler’s case to remove bugs, dirt, and/or water deposits that may have collected inside the case. This may be required more frequently during summer months. Inspect the cooling air intake filter during the summer months and clean if necessary.

#### **4.9.2.4 Software Update**

The operator must update software to the latest version of software as they become available from the manufacturer.

### **4.9.3 Trouble Isolation**

The instruments in Polk County Air Quality’s air monitoring network are very reliable. However, after a period of continuous use problems may occur. Leaks in the system, dirt build up and pump failure are typical. After time, the operator should be able to quickly distinguish the symptoms and causes of equipment failure.

It is suggested that each station operator consult the Partisol®-2025i Sequential Air Sampler Instruction Manual and compile personal notes on troubleshooting as they gain experience with the instruments. The operator is encouraged to contact the manufacturer when attempting any repairs.

**The Operator’s manual is the best resource the station operator has for the information on the operation and maintenance of the PM2.5 and PM10 samplers.**

**4.10 Quality Assurance (Accuracy - Audits)**

Each of the operating PM2.5 and PM10 samplers will be audited once during each calendar quarter by the designated Quality Assurance Officer utilizing the procedures and calculations specified in 40 CFR 58, Appendix A, "Quality Assurance Requirements for State and Local Air Monitoring Stations (SLAMS)."

Perform audits as described by procedures outlined in Section 4.12.4.1, Temperature, Pressure and Flow Verifications, of this SOP. Table 4-1 below outlines the activities to be audited and their acceptable criteria. All steps are to be recorded on the “Audit Field Sheets” Forms 1 & 2, Appendix A.

Audits should be conducted in the same way as the routine verifications performed once every four weeks, with the following exceptions:

- Audits must be done using standards that are not used for routine calibrations and checks, and should be done by someone other than the routine operator. For example, special FTS and filters are used for flow audits.
- Acceptance criteria for audits are given in the Operational Evaluations section of the Redbook MQO tables and below in Table 4-1. However data should not be invalidated based on the results of an audit alone. An investigation initiated by the audit results may lead to the invalidation of data.
- Flow audit results are uploaded to AQS. The flows that are uploaded to AQS are observed with the FTS and its adapter in place. The actual flow is obtained from the audit standard. The indicated flow corresponds to the samplers own internal flow measurement device.

**Table 4-1 Audit Activities and Acceptance Criteria**

<b>Activity</b>	<b>Acceptance Criteria</b>
One Point Flow Rate Audit	+4% of Standard +5% of Design flow rate
Temperature audit (single point: ambient air inlet sensor, filter compartment, and filter temperature sensor)	± 2°C of Standard for the ambient and filter temperature sensors and ±4° of Standard for filter compartment sensor
Pressure Audit	± 10 mm Hg
External Leak Audit	< 25 mmHg
Internal Leak Audit	< 140 mmHg

#### **4.11 Data Quality Assessment**

For each calendar quarter and year, Polk County Air Quality will prepare data precision, accuracy and completeness reports for the Iowa Department of Natural Resources (Iowa DNR) and EPA-Region 7 in accordance with the current Letter of Agreement (LOA).

##### **4.10.1 Precision**

The precision for PM2.5 and PM10 will be evaluated and reported employing the frequencies, procedures and calculations outlined in the Code of Federal Regulations and current EPA guidance documents.

##### **4.10.2 Accuracy**

The accuracy will be evaluated and reported for PM2.5 and PM10 using results from the performance audits and the calculations specified in the Code of Federal Regulations and current EPA guidance documents.

##### **4.10.3 Data Completeness**

The completeness of the data will be determined for each monitoring instrument and expressed as a percentage. Percent valid data will be a gauge of the amount of valid data obtained from the monitoring instrument, compared to the amount expected under ideal conditions, or which were discontinued prior to the end of any reporting period for calculation purposes.

#### **4.12 Calibrations**

##### **4.12.1 Temperature Calibration**

Calibration of the temperature sensors is to be performed upon installation, annually, when monthly verifications or quarterly audits fail to meet the acceptance criteria with respect to the actual temperature as determined by a NIST traceable thermometer. The NIST thermometer must be recertified annually.

###### **4.12.1.1 Calibration of Ambient and Filter Temperature Sensors**

The temperature sensors are removed from their mounting position and placed in a constant temperature bath with a standard thermometer. The readings are compared and the sampler readings are adjusted accordingly. The following materials will be required:

- NIST traceable thermometer
- 3 vacuum bottles with lids
- Distilled water ice, crushed
- Distilled water
- 1 each, #0 and #1 Phillips head screwdriver
- 9/16 wrench

Prepare the thermal masses. Fill a vacuum bottle nearly full with crushed ice. Pour in water to cover the ice. Put the lid on. This will produce a temperature of 0.0°C ((±0.1°C) Cold). Fill another vacuum bottle with water that has been allowed to equilibrate to room temperature for several hours (Ambient). Heat some water, either on a hotplate or in a microwave oven, to about 40°C (Hot). Fill a third vacuum bottle with the heated water.











## Section 4: Discrete PM2.5 and PM10



Revised: February 23, 2023

Revision Number: 9

Perform a calibration of the ambient air and filter temperature sensors. If the sampler is not in stop mode, press  (run) key when the full screen is displayed. Remove the ambient temperature probe from the housing by loosening the screws holding the probe. Remove the cover that is over the sampling platform. Loosen the two screws on either side of the probe and remove the temperature probe from the sampling platform. Loosen the screw on the positioning ring and slide it off the probe. Remove the probe from the filter compartment while leaving the cable connected to the sampler.

Press  to return to the main menu screen. The sampler must be in Service Mode before attempting to calibrate the temperature probes. Scroll to Service Mode and press . Use the arrow keys to toggle the Service Mode field On or Off and press  to save.

Immerse the NIST traceable temperature standard, the ambient and the filter temperature probes in the ambient bath. Allow the readings to equilibrate for 5 minutes. Take five readings about one minute apart. If the readings appear to have stabilized, average the five readings and apply the correction for the standard thermometer (Note: The calibration is performed at ambient temperature, the reference thermometer and sampler sensors should be immersed together to the same depth in an insulated bottle or vacuum bottle that maintains a constant temperature). Press  to return to the main menu screen. Scroll to Audit and Calibration and press . Scroll to Calibration and press . Scroll to Ambient Temp and press . At the Calibrate Ambient Temp screen, enter the reference temperature reading in °C and press  to save the value. The Sampler automatically adjusts the corresponding offset based upon this input





Press  to return to the Calibration menu, scroll to Filter Temp and press . At the Calibrate Filter Temp screen, enter the reference temperature reading in °C and press  to save the value. The Sampler automatically adjusts the corresponding offset based upon this input.

**NOTE:** although Quality Assurance Document 2.12 (January, 2016) recommended a three point calibration of all temperature sensors, the 2025i software only allows for a one point calibration. Therefore, the 2025i samplers will be calibrated at one point, followed by a multiple point verification.

Place the ambient and filter temperature probes as well as the standard successively in the cold, ambient and hot baths. Take five readings of the standard thermometer and the filter/ambient temperature probes in each bath at 1-minute intervals. Average the readings for each of the devices. Apply the correction factor to the standard thermometer averages. Verify that the instrument sensors meet the  $\pm 2^{\circ}\text{C}$  accuracy requirement.

Reinstall the sensors. Secure the positioning ring on the filter temperature probe in the same position as when it was removed to assure proper positioning of the sensor.

#### 4.12.1.2 Calibration of the Filter Compartment Temperature Sensor

Perform a calibration of the filter compartment temperature sensor. It is not possible to remove the filter compartment temperature sensor so that it can be immersed in the thermal bath. Therefore, only a single point can be used in the calibration. Determine the current temperature at location of the filter compartment probe in the ventilated filter compartment of the Partisol®-2025i Sampler using the temperature standard. Press  to return to the Main Menu screen. Scroll to Audit and Calibration and press . Scroll to Calibration and press . Scroll to FComp Temp and press . Determine the current temperature (°C) at the location of the filter compartment sensor in the ventilated filter compartment using a reference thermometer. At the FComp Temp screen, use the pushbuttons to enter the reference value in °C and press  to save the value. The Sampler automatically adjusts the corresponding offset based on this input. Verify that the filter compartment temperature meet the  $\pm 2^{\circ}\text{C}$  accuracy requirement.

All steps are to be recorded on an “Annual Calibration Sheet” Form 3, Appendix A.

#### 4.12.1.3 Calculations

When the temperature standard is certified, a certificate is provided which gives corrections to the reading of the temperature standard ( $T_{\text{standard}}$ ). These correction factors (Corr Fact) must be added to the reading to correct to the actual temperature ( $T_{\text{actual}}$ ).

$$T_{\text{actual}} = T_{\text{standard}} + \text{Corr Fact}$$

For determining whether the calibration meets the accuracy requirements, calculate the difference between the corrected readings from temperature standard and the instrument sensors as:

$$\text{Difference} = T_{\text{sampler}} - T_{\text{actual}}$$









### 4.12.2 Pressure Calibration

Calibration of the ambient pressure sensor is to be performed upon installation and then annually or when monthly verifications or audits indicate a deviation greater than  $\pm 10$  mmHg from the actual pressure as determined by an NIST traceable barometer. The NIST barometer must be recertified annually.

#### 4.12.2.1 Calibration Procedures

The ambient pressure reading of the sampler is compared to the ambient pressure reading of a NIST traceable barometer. The readings are compared and the sampler calibration offset is adjusted if necessary. The following materials will be required:

- PM10/PM2.5 Calibration/Multi-point verification sheet
- NIST traceable barometer (pressure standard).

Place the sampler in stop mode by pressing the  (run) key when the full screen is displayed. Press  to return to the main menu screen. The sampler must be in Service Mode before attempting to calibrate the pressure sensor. Scroll to Service Mode and press . Use the arrow keys to toggle the Service Mode field On or Off and press  to save. Press  to return to the main menu screen. Scroll to Audit and Calibration and press . Scroll to Calibration and press . Scroll to Ambient Pressure and press . Document the initial offset value on the Calibration/Multi-point Verification Sheet.

Determine the current ambient station pressure with the NIST traceable barometer in mmHg (absolute pressure, not corrected to sea level). At the Calibrate Ambient Pressure screen, enter the reference pressure reading in mmHg and press  to save the value. The Sampler automatically adjusts the corresponding offset based upon this input. Document the final offset value on the Calibration/Multi-point verification sheet.

#### 4.11.2.2 Calculations

To convert the barometer readings from inHg to mmHg:

$$\text{inHg} \times 25.4 = \text{mmHg}$$

#### 4.12.3 Flow Calibration

Flow calibrations should be performed upon installation, annually, following a major electrical or mechanical maintenance, such as replacement of a circuit board or rebuilding of the sampling pump assembly, or when routine flow rate verifications or audits fail to meet the acceptance criteria.

For a three-point calibration of a 16.7 L/min flow rate set point, Thermo Scientific recommends the following parameter values.

Min. Flow: 15.0 L/min (10% below the usual 16.7 L/min set point)

Max Flow: 18.4 L/min (10% above the usual 16.7 L/min set point)

The flow of the sampler is compared to a NIST traceable flow calibration device. The readings are compared and the sampler calibration offset is adjusted if necessary.

##### 4.12.3.1 Calibration Procedures

A 3-point flow calibration at flow rates of 15.0, 16.7, and 18.4 L/min is performed using a NIST traceable flow meter. The following materials will be required:

- NIST traceable flow transfer standard – Examples include: BIOS International, Dry Cal, DC-1 Flow Calibrator, or Streamline FTS from Chinook Engineering. **Note:** that regardless of what the settings are for Standard Temperature and Pressure in the System Set-Up Screen, the current flow displayed on the LCD screen of the sampler will be given at

## Section 4: Discrete PM2.5 and PM10

Revised: February 23, 2023











Revision Number: 9





local conditions. Therefore, the FTS should be configured to display the flow in local conditions for PM2.5 and PM10 sampling.

- Flow Audit Adapter
- PM2.5/PM10 Calibration Sheet

Perform an external leak check, temperature and pressure calibrations as described in sections 4.12.1.1 - 4.12.1.2 before executing the flow calibration procedure below.

Before beginning this procedure, an unused filter must be in place in the sampler. See Section 4.12.4 for instructions.

Note: When using the Streamline FTS Flow Transfer Standard to calibrate the flow of the Partisol Sampler, perform the following steps to enter the m and b constants from the Streamline FTS into the Sampler. This will allow the operator to enter the manometer pressure drop (in inches of H<sub>2</sub>O) and the Sampler will then calculate the actual flow automatically. Place the sampler in stop mode by pressing the  (run) key when the full screen is displayed. Place the sampler in Service Mode by pressing  repeatedly to display the Main Menu, scroll to Service and press . Press  repeatedly to display the Main Menu, scroll to Instrument Setup and press  to display the Instrument Setup menu. Scroll to Flow Calibration Setup and press  to display the Flow Calibration Setup menu. Scroll to Use FTS Constants and press  to toggle the value from No to Yes. Scroll to Flow and press  to display the Cal Setup Flow menu. Scroll to FTS Constant M or FTS Constant B and press  to display the FTS Constant M or FTS Constant B screen. Enter the proper value for the constant and press . Press  repeatedly to return to the Main Menu

Remove the 1<sup>st</sup> stage inlet from the external sample tube of the Partisol Sampler. Install the Flow Audit Adapter with its valve open. Attach the flow measurement device (flow standard) to the Flow Audit Adapter. Allow the temperature of the standard to equilibrate to that of the sampler for 10 to 15 minutes. Press  repeatedly to return to the Main Menu. Scroll to Audit and Calibration and press  to display the Audit and Calibration menu. Scroll to Calibration and press  to display the Calibration menu. Scroll to Flow and press  to display the Calibration For Flow menu.

Default calibration setpoints are already entered into the sampler. The following values are used for a three-point calibration of the 16.7 L/min flow rate setpoint:

Setpoint 1 (Min Flow): 15.0 L/min (10% below the usual 16.7L/min set point)

Setpoint 2: The usual 16.7 L/min setpoint

Setpoint 3 (Max Flow): 18.4 L/min (10% above the usual 16.7 L/min set point)

Scroll to Start Calibration and press . The Sampler will automatically open the proper valves and start the pump. Allow 15 minutes for the flow to stabilize, enter the actual flow rate measured by the Flow Calibration Device. When using the Streamline FTS, instead of entering the flow value measured by the Flow Calibration Device, enter the pressure drop (in inches of H<sub>2</sub>O) in the Actual Flow field. The system will automatically calculate the proper actual flow using the pressure drop and the measured values of ambient pressure and temperature. During the calibration procedure, the sampler automatically proceeds to the next flow rate plateau.

Following the flow calibration perform a one point flow rate verification (Section 4.12.1.5). If the flow verification differs by  $\pm 2\%$  the flow rate calibration must be redone.

Restore the sampling hardware to its original state by removing the flow metering hardware and reinstalling the inlet onto the external sample tube. Press  repeatedly to return to the Main Menu.

All steps are to be recorded on an “Annual Calibration Sheet” Form 3, Appendix A.

### 4.13 Sampler Operations

This section describes the routine field operations for the Thermo Scientific Model 2025*i* Sequential Air Sampler. Routine operations are defined as those performed on a monthly, or more frequent, basis. Results should be recorded on the respective analyzers field sheet, Form 4 or Form 5.

#### 4.13.1 Quality Control

##### 4.13.1.1 Ambient, Filter, and Filter Compartment Temperatures

Sampler measured (current) temperature must be within  $\pm 2^{\circ}\text{C}$  of the temperature measured by an external transfer standard for the ambient and filter temperature sensors. The filter compartment temperature sensor must be within  $\pm 4^{\circ}\text{C}$  of the temperature measured by an external transfer standard. Failure to meet the acceptance criteria may result in the invalidation of samples back to the last successful temperature verification.

Perform temperature verifications at least once every 4 weeks or as needed. See section 7-3 in the Partisol®-2025*i* Sequential Air Sampler Instruction Manual, Thermo Scientific, April 15, 2015.

##### 4.13.1.2 Ambient Pressure

Current ambient pressure must be within  $\pm 10$  mmHg of actual ambient pressure. Failure to meet this criteria may result in the invalidation of samples back to the last successful pressure verification.

$$\text{Converting inHg to mmHg: inHg} \times 25.4 = \text{mmHg}$$

Perform ambient pressure verification at least once every 4 weeks or as needed. See section 7-6 in the Partisol®-2025*i* Sequential Air Sampler Instruction Manual, Thermo Scientific, April 15, 2015.

#### **4.13.1.3 External Leak Check**

For a sampler external leak check, a pressure drop of 25 mmHg or less is a passing check.

Perform external leak check at least once every 4 weeks or whenever the flow path is broken. See section 7-7 in the Partisol®-2025i Sequential Air Sampler Instruction Manual, Thermo Scientific, April 15, 2015.

#### **4.13.1.4 Internal Leak Check**

For a sampler internal leak check, a pressure drop of 140 mmHg or less is a passing check.

Perform internal leak check at least once every 4 weeks or whenever the flow path is broken. See Section 7-11 in the Partisol®-2025i Sequential Air Sampler Instruction Manual, Thermo Scientific, April 15, 2015.

#### **4.13.1.3 Flow Rate Verification**

A one-point flow verification is subjected to three checks. “Current” refers to the Samplers measured flow and “Actual” refers to the flow transfer standard:

- Percent difference from “Actual”:  
$$[(\text{Current}-\text{Actual})/\text{Actual}] \times 100 < \pm 4\%$$
- Percent difference from Design flow rate with FTS attached:  
$$[\text{Actual} - \text{Design Flow}(16.70)/\text{Design Flow}(16.70)] \times 100 < \pm 5\%$$
- Percent difference from Design flow rate with the 1<sup>st</sup> Stage inlet installed:  
$$[\text{Current} - \text{Design Flow} (16.70)/\text{Design Flow} (16.70)] \times 100 < \pm 2\%$$

Perform flow rate verification at least once every 4 weeks or as needed. See section 7-8 in the Partisol®-2025i Sequential Air Sampler Instruction Manual, Thermo Scientific, April 15, 2015.

Acceptance criteria can be found in Table 4-3: The Measurement Quality Acceptance Tables from the Quality Assurance Handbook for Air Pollution Measurement Systems, Volume II, Appendix D Revision 1, March, 2017.

#### **4.13.1.4 Maintenance**

See Chapter 10 in the Partisol®-2025i Sequential Air Sampler Instruction Manual, Thermo Scientific, April 15, 2015.

Table 4-2 summarizes the calibration, verification and maintenance frequencies.

**Table 4-2 Calibration, Verification, and Maintenance Check Intervals**

Activity	Frequency	Acceptance Criteria
Single point temperature verification of ambient air inlet sensor, filter compartment and filter temperature sensor	1/4 Weeks	$\pm 2^{\circ}\text{C}$ of Standard for ambient and filter temp. sensors and $\pm 4^{\circ}\text{C}$ of Standard for filter compartment sensor
Temperature Multi-point Verification	After every calibration	$\pm 2^{\circ}\text{C}$ of Standard
Temperature Calibration	As needed or at least 1/year	Do multipoint verification immediately after calibration
Ambient Pressure Verification	1/4 Weeks	$\pm 10$ mmHg
Ambient Pressure Calibration	As needed or at least 1/year	$\pm 10$ mmHg
Filter Pressure Verification	1/year	$\pm 10$ mmHg
One-Point Flow Verification	1/4 Weeks and immediately following a calibration	$\pm 4\%$ of Standard $\pm 2\%$ for the immediate post calibration flow verification $\pm 5\%$ of Design Flow rate
Multi Point Flow Calibration	1/year or as needed	$\pm 4\%$ of Standard
External Leak Check	1/4 Weeks or as needed	25 mmHg/min
Internal Leak Check	1/4 Weeks or as needed	140 mmHg/min
Cleaning of VSCC	1/4 Weeks or as needed	
Disassemble, Inspect and Clean PM 10 Sample Inlet	Every 15 Sampling Events and at least Monthly	
Clean pass through tube	Every 15 Sampling Events and at least monthly	
Clean Interior of Sample Case	1/4 Weeks	
Water Collector Bottle Inspection	Every 5 Sampling Events	
Replace particle trap filter in bowl behind filter shuttle assembly	As Needed	Part # 33-000393

#### 4.13.2 Procedures

New station operators will be provided with on-site training by an experienced operator before they operate a station on their own. The following procedures are intended to assist the operator in performing and documenting monitoring procedures. Monitoring personnel must become familiar with the Operating and Service Manuals for the Thermo Scientific 2025i Sequential Air Sampler.

Included are the steps involved in verifying sampler performance characteristics prior to starting a sampling run, programming a sampling run for midnight to midnight 24-hour sampling 1 day out of every 3 or 6 days, and retrieving data after a sampling run in the field has concluded. The following materials are required:

- Supply Magazine
- Clean, empty storage magazine
- 1 – Leak check cassette with impermeable disk
- 1 – Empty Cassette with no screen or filter
- 1 – External leak check cassette with 47mm Teflon filter
- 1 – VSCC for PM2.5 or pass through tube for PM10
- NIST traceable thermometer (temperature standard)
- NIST traceable barometer (pressure standard)
- NIST traceable flow meter (flow standard)

- Flow adapter
- Form with cassette ID #'s and magazine ID #'s
- 1-USB Flash drive for data acquisition
- Sampling data sheet
- Transport container
- Ammonia based general purpose cleaner
- Cotton swabs
- Small soft bristle brush
- Paper towels
- Distilled water
- Silicone based stopcock grease
- Small screwdriver
- Small crescent wrench

#### **4.13.3 Maintenance of the Very Sharp Cut Cyclone (VSCC)**

Figure 4-3 is a schematic drawing showing the Very Sharp Cut Cyclone (VSCC). The VSCC is designed and manufactured by BGI Incorporated. Its intended use is as an equivalent fine particulate matter separator in place of the US EPA WINS Impactor for PM2.5 sampling in any commercial model of the U.S. EPA Federal Reference Method (FRM) Samplers. BGI developed the VSCC, and verified in laboratory and field, to have several operational advantages compared to the WINS, insofar as it is a dry separator and requires cleaning at infrequent intervals.

The intervals between cleaning of the VSCC should not exceed 30 days of 24-hour sampling. Recommended cleaning materials include mineral free water and lint free lab wipes.

**To Disassemble a BGI VSCC:** remove the VSCC from its installed position in the instrument. Pull off the side transfer tube. If it is too tight to remove by hand, pry it off with a rigid plastic lever. Care should be taken to not damage the two “O” ring seals. Remove the top cap and grit pot by unscrewing. Wet a lint free wipe with water and remove all visible deposits. These are most likely to be found at the bottom of the cone and inside the grit pot. Inspect all “O” rings for shape and integrity. If at all suspect, replace. Lubricate all “O” rings with light grease. It is important to well lubricate the transfer tube to avoid difficult disassembly. Assemble in reverse order and reinstall. Perform a leak check according to manufacturer’s operating manual specifications.

#### **4.13.4 Pre-Sampling Verification**

At a minimum, perform verifications and leak checks at the frequency listed in the Quality Control Section 4.12.1 of this SOP.

**NOTE:** Verifications should be performed on a non-sampling day with the exception of those running on a daily basis. If disrupting a sampling event cannot be avoided, the active filter must be removed and protected from contamination and damage by storing it in a clean container between uses. Also, the active sampling period must not be interrupted for more than 1-hour in order to achieve a minimum overall sampling period of 23 hours.

Install a supply magazine with an internal leak check cassette (with impermeable disk), an external leak check cassette (with 47mm Teflon filter), and an empty cassette (with no screen or



## Section 4: Discrete PM<sub>2.5</sub> and PM<sub>10</sub>

Revised: February 23, 2023

Revision Number: 9

filter). The empty cassette should be in the topmost position, while the Teflon in 2<sup>nd</sup> and impermeable disk in 3<sup>rd</sup> position. Install the supply magazine in the left side of the sampler.

**Figure 4-3: Schematic Drawing of the Air Flow through a Very Sharp Cut Cyclone**

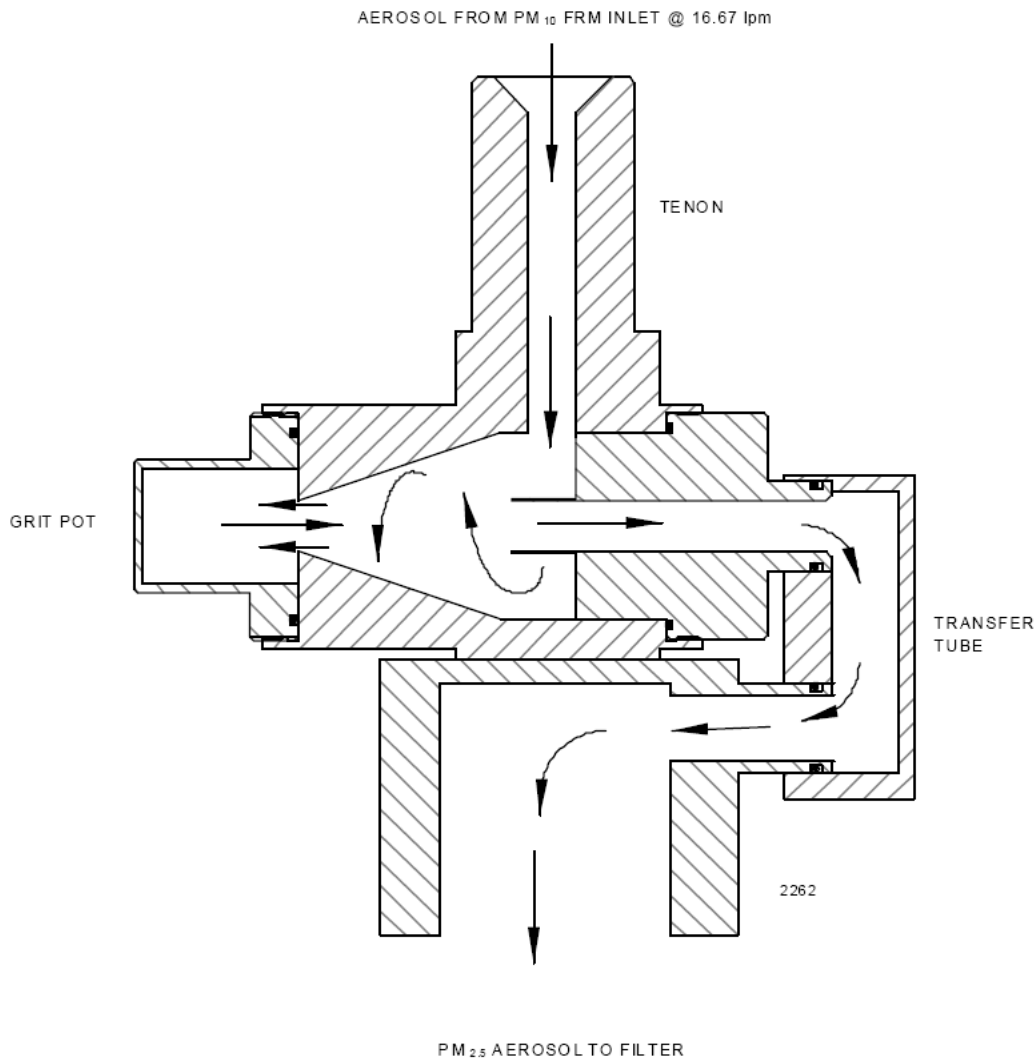

Maintenance and performance verification can be done in either the Stop or Wait or Sampling Modes. The Sampler is generally in Wait or Stop Mode prior to performing verifications, but verifications can be performed by interrupting a sampling event. If the Sampler is in Stop mode proceed with the verification. If the Sampler is running a sample and verification must be performed, interrupt the sample by entering the audit mode. When the verification is completed, replace the partially exposed filter and resume the sampling event. Remove the right filter magazine with the exposed filters from the previous runs, cap the magazine and place in a cooled

container for transport to the lab or weighing room. Install a clean empty storage magazine in the right side of the sampler. Unlatch and open the sampler's top cover.







#### **4.13.4.1 Temperature, Pressure and Flow Verifications**

Verify the sampler ambient temperature by measuring the temperature (°C) at the ambient temperature sensor using an external thermometer. Compare the actual temperature (°C) with the Amb Temp (current) displayed in the Audit Screen. If the actual and current readings are not within  $\pm 2^{\circ}\text{C}$ , perform the ambient temperature calibration procedure outlined in Section 4.11.1.1 of this SOP.

Verify the sampler filter temperature by measuring the temperature (°C) at the filter temperature sensor using an external thermometer (actual). Do this by inserting the temperature sensor probe into the sampling platform from above. Compare the actual temperature (°C) with the Filt Temp (current) displayed in the Audit Screen. If the actual and current readings are not within  $\pm 2^{\circ}\text{C}$ , perform the filter temperature calibration described in Section 4.11.1.1 of this SOP.

Verify the sampler compartment temperature by measuring the temperature (°C) at the compartment temperature sensor using an external thermometer (actual). Do this by placing the temperature sensor probe next to the compartment temperature sensor. Compare the actual temperature (°C) with the Filt Comp Temp (current) displayed in the Audit Screen. If the actual and current readings are not within  $+4^{\circ}\text{C}$ , perform the filter compartment temperature calibration described in Section 4.11.1.2 of this SOP.

Verify the sampler ambient pressure by measuring the ambient station pressure in mmHg with an external barometer. Verify that the value for the ambient pressure (current) displayed in the Audit Screen is within  $\pm 7$  mmHg of the actual barometric pressure. If the pressure is not within  $\pm 7$  mmHg an investigation will be done that may require the need to recalibrate. Refer to Section 4.11.2 of this SOP for pressure calibration procedures.









Perform an external leak check. Remove the 1<sup>st</sup> stage inlet from the sampler tube and install the flow audit adapter on the sampler tube. Press  to return to Audit and Calibration menu, scroll to Advance Filter, press  then press  to confirm advance verification filter cassette into sampling (inline) position. Close the valve on the flow audit adapter. Scroll to Leak Checks press , scroll to External and press . Press  to begin testing. A Pass or Fail message will display at the end of the leak check cycle where you will slowly open the valve. If a Fail message is displayed, repeat the leak check with a different cassette. If a second leak check “fails”, see the instructional manual provided by the manufacturer and do not resume sampling until the sampler consistently passes external leak checks. If the condition that caused the leak check to fail is likely to have affected previous samples, they may be subject to invalidation.







Verify sampler flow. Attach the flow standard (BIOS or FTS) to the flow audit adapter. If using a Streamline FTS make sure the sampler is setup properly. See section 4.5.3.5 for

## Section 4: Discrete PM2.5 and PM10

Revised: February 23, 2023

Revision Number: 9

instructions on setup. Press  repeatedly to display Main Menu. Scroll to Audit and Calibration, press . Scroll to Audit and press . Scroll to Flow (off-on) and press  to turn flow on and  to turn flow off. Scroll down to FTS Flow and press . Once flow has stabilized (allow 15 minutes for flow to stabilize) enter FTS manometer readings (inches of water) and press . Record Sampler flow and FTS flow on verification sheet. Remove FTS and reinstall a clean PM-10 inlet on sample tube. See section 13.14 for 1st stage inlet cleaning instruction. Record current sampler flow. Scroll to flow and press  to turn off flow. See section 4.12.1.5 for the acceptance criteria for a flow rate verification. However, if the flow verification exceeds  $\pm 3\%$  an investigation will be performed that may lead to a flow recalibration. If the criteria for these parameters are not met, perform a flow calibration (refer to Section 4.11.3 of this SOP for guidance). Failure to meet this criteria may result in the invalidation of samples back to the last successful flow rate verification.

Perform an internal leak check. Press  to return to Audit and Calibration menu, scroll to Advance Filter, and press  then press  to confirm advance solid disk into sampling position. Scroll to Leak Checks press , scroll to internal press . Press  to begin testing. If a Fail message is displayed, repeat the leak check. If a second leak check “fails”, see the service manual provided by the manufacturer and do not resume sampling until the sampler consistently passes internal leak checks. If the condition that caused the leak check to fail is likely to have affected previous samples, they may be subject to invalidation.

Restore the sampling hardware to its original state by removing the flow transfer standard and replacing the 1<sup>st</sup> stage inlet on sampler tube. Reinstall the VSCC for the PM2.5 or the pass through adapter tube for PM10.

All steps are to be recorded on a “Verification Field Sheet” Forms 4 & 5, Appendix A.

### 4.13.4.2 Maintenance of the Top Acceleration Assembly.

Mark the top plate deflector cone and lower plate with a pencil scribe to facilitate proper orientation for easier reassembly after cleaning and maintenance. Using a Phillips blade screwdriver, remove the four pan head screws from the top of the top plate, and lift the top plate off the four threaded spacer standoffs and set aside. Inspect the insect screen for contamination and clean by lifting the screen off the lower plate rain deflector and brush or rinse with water until clean. Dry and reinstall. Using a general purpose cleaner and paper towel, clean the top plate deflector cone and internal wall surface of the acceleration assembly. Be sure that after cleaning is complete, the acceleration nozzle is clean. If not, use a cotton swab and cleaner to remove contamination. Inspect the large diameter impactor nozzle O-ring for wear. Replace if necessary, or using a light coating of silicone grease, apply a thin film on the O-ring itself; and likewise a small light coating

on the aluminum threads of the acceleration assembly. After reinstalling the bug screen, align the top plate markings with the lower plate markings. The four holes in the top plate should align with the four spacer standoffs. Insert and tighten securely the four pan head screws.

#### **4.13.4.3 Maintenance of the Lower Collector Assembly**

It is on the collector plate that most of the contamination in the inlet is found. The threads should be cleaned to facilitate a tight seal when the two halves are reassembled. Follow the steps below to clean the lower collector assembly:

Using a general purpose cleaner with a paper towel, clean the collector assembly walls and the three vent tubes. A cotton swab may be necessary to clean these vent tubes. Likewise, clean the bottom side of the collector assembly. Using a cotton swab, also clean the weep hole in the collector plate where the moisture runs out to the moisture trap. Remove the rain jar and clean. Inspect the brass nipple fitting to ensure tightness and non-blockage. When reinstalling the rain jar, place a light coating of silicone grease on the gasket inside the cap of the rain jar. This will ensure a leak-free fit. Inspect the two inlet-to-inlet tube sealing O-rings for wear. Replace if necessary. Use a light coating of silicone grease on these O-rings to ensure that a seal is made when reinstalled on the 1 ¼" OD sampler tube.

#### **4.13.4.4 Reassemble and Reinstallation of Inlet**







Reassemble the top and bottom inlet assemblies until the threads tighten. Hand-tighten only. Carefully place the inlet back on top of the 1 ¼" OD sample tube. Take care not to damage the internal O-rings. The performance verification and maintenance is now complete. Replace the 1<sup>st</sup> stage inlet on the sample tube by pressing down until it hits a stop.

**Note:** If a problem is recognized while performing any maintenance, diagnostic, external, or internal checks which has or could affect data a corrective action form is to be filled out describing the problem identified and the action taken to correct the problem. All information should be recorded on a "Corrective Action Form" Form 6, Appendix A.

#### **4.13.5 Programming the Sampler**

This section describes the procedures for programming the sampler for a sampling run. A supply magazine with the desired number of pre-weighed 47 mm Teflon filters in cassettes (including blanks) should be installed in the left side of the enclosure and a clean empty storage magazine should be installed on the right side of the enclosure. Check to make sure the magazine number on the Chain-of-Custody sheets matches the number on the magazine itself.





The filter ID list is uploaded to the Partisol 2025*i* through the use of the USB port. The file includes filter type, filter ID, and cassette ID(if needed). To create a filter list a file is created in the lab on a PC and then saved to a USB flash drive. Create the file using the filter ID upload file template with filter type and filter ID. The Partisol 2025*i* only recognizes certain file nomenclature. When the file is saved it must be saved with file name "filter\_list" followed by five number sampler ID and end with .csv file extension. Example: filter\_list20455.csv

Upload the file to the Partisol 2025i. Insert USB flash drive into the Partisol 2025i. Press  to return to Main menu, scroll to USB press , scroll to Port 1 press , scroll to Import Sample FilterList and press . Scroll to appropriate filter list and press  to upload. Press  to return to Main menu. Scroll to Edit Filter / Cassette ID and confirm data in #, Filter, Cassette and Blank column's match filter chain-of-custody sheet for each filter. Following confirmation press  to return to Main menu.

#### 4.13.6 Post-Sampling Verification and Data Retrieval

This section describes the procedures for verifying the sampling run status, verifying filter integrity/sequence and retrieving the sampling run data. The sample will be removed from the monitor within 177 hours (7 days 9 hours) of the end of the sample run.

Data can be displayed on the screen or downloaded to a personal computer, USB flash drive or remotely via iPort software while in the Stop, Sampling, Done, Error or Audit modes.

Download data to a USB flash drive. To download sample data from sampler using a USB flash drive (USB stick), insert USB stick into an available USB port on front of electronics enclosure of Sampler. Press  and scroll down to locate USB menu item on Main Menu and press . The available USB ports will be displayed. Select port used in Step 1 and press . The list of available USB actions is shown. Scroll to instrument sample data, select Export Data logs and press . Select desired data records to download and follow instructions on instrument display. When complete, remove USB stick from Sampler.

Filter data can also be downloaded remotely via iPort software. Ensure the sampler is connected via an Ethernet connection to the organizations network. Use the Thermo Fisher Scientific "iPort Users Manual" to program the software to connect to the sampler. Data may be downloaded by selecting "Connect>TCP Connect>Connect" followed by "Instrument>Load Records>Filter Records>Save to File". Select a file of choice and select "OK".

Cassette magazines can be changed in any mode (except at the time a filter change is occurring).

Visually check to ensure that the filter was not damaged during sampling. The following checks should be performed to identify problems while operator is still in the field:

- Ensure that the number of filters being picked up corresponds with the number of chain of custody sheets filled out for that time period.
- Check to see if the filters came out in the expected order.
- Operators can also verify that the number of filters in the magazine on the left side correspond to future sampling periods.
- Check to see if each filter was exposed by reviewing the data files.
- Check for consistency between the magazine, electronic data file and paperwork.

Remove and cap the storage magazine containing the sampled filters. Place the capped magazine in a metal transport container. Make sure that a loaded supply magazine and an empty storage magazine are installed before the scheduled start of the next sampling run. For more specific

information on transport and storage of sampled filters, refer to Section 19 of Polk County Air Quality SOP.

#### **4.14 Validation and Reporting of Data**

##### **4.14.1 Calculation Validation**

Data that are needed to compute the mass concentration of PM2.5 and PM10 originate from two main sources: field operations and laboratory operations. Laboratory operations are the responsibility of The State of Iowa Hygienic Lab, and are better outlined in SHL's SOP. Data must be validated to ensure that all reported PM2.5 and PM10 measurements are accurate relative to the overall scope of the quality assurance program. When the final mass concentration of PM2.5 or PM10 in a sample has been computed, the validation procedure not only will check on these computations, but also will aid in the flagging of questionable mass concentrations (i.e., extremely high or low values). For example, comparisons should be made among discrete PM2.5 and PM2.5 BAM data to check for outliers in the data. Therefore, should a mass concentration approach the primary or secondary ambient air quality standard, this validation procedure will provide checks for all preliminary field and laboratory operations. The steps of the calculation validation procedure are outlined in Section 20 of the Polk County Air Quality SOP.

##### **4.14.2 Final Data Validation**

Data that satisfies the requirements of this SOP, the Polk County QAPP, and the "PM2.5 Mass Validation Criteria" will be certified as valid.

##### **4.14.3 Data Reporting**

Data is coded into telemetry system database from the laboratory reports. After the data is logged and edited the monitoring specialists will prepare monthly, quarterly and annual summary reports and transmit the data to the Iowa Department of Natural Resources Air Quality Bureau.

Table 4-3: Measurement Quality Objectives

PM<sub>2.5</sub> Filter Based Local Conditions Validation Template

1) Criteria (PM <sub>2.5</sub> LC)	2) Frequency	3) Acceptable Range	Information /Action
<b>CRITICAL CRITERIA- PM<sub>2.5</sub> Filter Based Local Conditions</b>			
<b>Field Activities</b>			
<i>Sampler/Monitor</i>	NA	<i>Meets requirements listed in FRM/FEM/ARM designation</i>	1) 40 CFR Part 58 App C Sec. 2.1 2) NA 3) 40 CFR Part 53 & <a href="#">FRM/FEM method list</a>
<b>Filter Holding Times</b>			
<i>Pre-sampling</i>	<i>all filters</i>	<i>≤ 30 days before sampling</i>	1, 2 and 3) 40 CFR Part 50, App. L Sec. 8.3.5
<i>Sample Recovery</i>	<i>all filters</i>	<i>≤ 7 days 9 hours from sample end date</i>	1, 2 and 3) 40 CFR Part 50, App. L 10.10
<i>Sampling Period (including multiple power failures)</i>	<i>all filters</i>	<i>1380-1500 minutes, or if value &lt; 1380 and exceedance of NAAQS <sup>4/</sup> midnight to midnight local standard time</i>	1, 2 and 3) 40 CFR Part 50 App L Sec. 3.3 and 40 CFR Part 50 App N Sec. 1 for the midnight to midnight local standard time requirement
<b>Sampling Instrument</b>			See details if less than 1380 min sampled
<i>Average Flow Rate</i>	<i>every 24 hours of op</i>	<i>average within 5% of 16.67 liters/minute</i>	1, 2 and 3) Part 50 App L Sec. 7.4.3.1
<i>Variability in Flow Rate</i>	<i>every 24 hours of op</i>	<i>CV ≤ 2%</i>	1, 2 and 3) 40 CFR Part 50, App L Sec. 7.4.3.2
<i>One-point Flow Rate Verification</i>	<i>every 30 days each separated by 14 days</i>	<i>&lt; ± 4.1% of transfer standard &lt; ± 5.1% of flow rate design value</i>	1, 2 and 3) 40 CFR Part 50, App L, Sec. 9.2.5 and 7.4.3.1 and 40 CFR Part 58, Appendix A Sec. 3.2.1
<i>Design Flow Rate Adjustment</i>	<i>After multi-point calibration or verification</i>	<i>&lt; ± 2.1% of design flow rate</i>	1, 2 and 3) 40 CFR Part 50, App. L, Sec. 9.2.6
<i>Individual Flow Rates</i>	<i>every 24 hours of op</i>	<i>no flow rate excursions &gt; ± 5% for &gt; 5 min. <sup>4/</sup></i>	1, 2 and 3) 40 CFR Part 50, App. L Sec. 7.4.3.1
<i>Filter Temp Sensor</i>	<i>every 24 hours of op</i>	<i>no excursions of &gt; 5° C lasting longer than 30 min <sup>4/</sup></i>	1, 2 and 3) 40 CFR Part 50, App. L Sec. 7.4.11.4
<i>External Leak Check</i>	<i>Before each flow rate verification/calibration and before and after PM<sub>2.5</sub> separator maintenance</i>	<i>&lt; 80.1 mL/min (see comment #1)</i>	1) 40 CFR Part 50 App L, Sec. 7.4.6.1 2) 40 CFR Part 50 App L Sec. 9.2.3 and Method 2-12 Sec. 7.4.3 3) 40 CFR Part 50, App. L, Sec. 7.4.6.1
<i>Internal Leak Check</i>	<i>If failure of external leak check</i>	<i>&lt; 80.1 mL/min</i>	1) 40 CFR Part 50, App. L, Sec. 7.4.6.2 2) Method 2-12, Sec. 7.4.4 3) 40 CFR Part 50, App. L, Sec. 7.4.6.2
<b>Laboratory Activities</b>			

Section 4: Discrete PM2.5 and PM10

Revised: February 23, 2023

Revision Number: 9

1) Criteria (PM2.5 LC)	2) Frequency	3) Acceptable Range	Information /Action
<i>Post-sampling Weighing</i>	<i>all filters</i>	<i>Protected from exposure to temperatures above 25C from sample retrieval to conditioning</i>  <i>≤10 days from sample end date if shipped at ambient temp, or</i> <i>≤ 30 days if shipped below avg ambient (or 4° C or below for avg sampling temps &lt; 4° C) from sample end date</i>	1, 2 and 3) 40 CFR Part 50 App L Sec. 8.3.6 and L Sec. 10.13.  See technical note on holding time requirements at : <a href="https://www3.epa.gov/ttn/amtic/tpmpolguid.html">https://www3.epa.gov/ttn/amtic/tpmpolguid.html</a>
<i>Filter Visual Defect Check (unexposed)</i>	<i>all filters</i>	<i>Correct type &amp; size and for pinholes, particles or imperfections</i>	1, 2 and 3) 40 CFR Part 50, App. L Sec. 10.2
<b>Filter Conditioning Environment</b>			
<i>Equilibration</i>	<i>all filters</i>	<i>24 hours minimum</i>	1, 2 and 3) 40 CFR Part 50, App. L Sec. 8.2.5
<i>Temp. Range</i>	<i>all filters</i>	<i>24-hr mean 20.0-23.0° C</i>	1, 2 and 3) 40 CFR Part 50, App. L Sec. 8.2.1
<i>Temp. Control</i>	<i>all filters</i>	<i>&lt; 2.1° C SD* over 24 hr.</i>	1, 2 and 3) 40 CFR Part 50, App. L Sec. 8.2.2 SD use is a recommendation
<i>Humidity Range</i>	<i>all filters</i>	<i>24-hr mean 30.0% - 40.0% RH or</i> <i>Within ±5.0 % sampling RH but ≥ 20.0%RH</i>	1, 2 and 3) 40 CFR Part 50, App. L Sec. 8.2.3
<i>Humidity Control</i>	<i>all filters</i>	<i>&lt; 5.1 % SD* over 24 hr.</i>	1, 2 and 3) 40 CFR Part 50, App. L Sec. 8.2.4 SD use is recommendation
<i>Pre/post Sampling RH</i>	<i>all filters</i>	<i>difference in 24-hr means &lt; ± 5.1% RH</i>	1, 2 and 3) 40 CFR Part 50, App. L Sec. 8.3.3
<i>Balance</i>	<i>all filters</i>	<i>located in filter conditioning environment</i>	1, 2 and 3) 40 CFR Part 50, App. L Sec. 8.3.2
<i>Microbalance Auto-Calibration</i>	<i>Prior to each weighing session</i>	Manufacturer's specification	1) 40 CFR Part 50, App. L, Sec. 8.1 2) 40 CFR Part 50, App. L, Sec. 8.1 and Method 2.12 Sec. 10.6 3) NA
<b>OPERATIONAL EVALUATIONS TABLE PM<sub>2.5</sub> Filter Based Local Conditions</b>			
<b>Field Activities</b>			
<i>One-point Temp Verification</i>	every 30 days	< ± 2.1°C	1) 40 CFR Part 50, App. L, Sec. 9.3 2) <u>Method 2.12</u> Sec. 7.4.5 and Table 6-1 3) Recommendation
<i>Pressure Verification</i>	every 30 days	< ± 10.1 mm Hg	1) 40 CFR Part 50, App. L, Sec. 9.3 2) Method 2.12 Sec. 7.4.6 and Table 6-1 3) Recommendation
<b>Annual Multi-point Verifications/Calibrations</b>			
<i>Temperature multi-point Verification/Calibration</i>	on installation, then every 365 days and once a calendar year	< ± 2.1°C	1) 40 CFR Part 50, App. L, Sec. 9.3 2 and 3) Method 2.12 Sec. 6.4.4 Table 6-1



Section 4: Discrete PM2.5 and PM10

Revised: February 23, 2023

Revision Number: 9

1) Criteria (PM2.5 LC)	2) Frequency	3) Acceptable Range	Information /Action
<i>Pressure Verification/Calibration</i>	on installation, and on one-point verification failure	$< \pm 10.1$ mm Hg	1) 40 CFR Part 50, App. L, Sec. 9.3 2 and 3) Method 2.12 Sec. 6.5 Sampler BP verified against independent standard verified against a lab primary standard that is certified as NIST traceable 1/year
<i>Flow Rate Multi-point Verification/Calibration</i>	<i>Electromechanical maintenance or transport or every 365 days and once a calendar year</i>	$< \pm 2.1\%$ of transfer standard	1) 40 CFR Part 50, App. L, Sec. 9.2. 2) 40 CFR Part 50, App. L, Sec. 9.1.3, Method 2.12 Sec. 6.3 & Table 6-1 3) Recommendation
Other Monitor Calibrations	per manufacturers' op manual	per manufacturers' operating manual	1, 2 and 3) Recommendation
Precision			
<i>Collocated Samples</i>	<i>every 12 days for 15% of sites by method designation</i>	CV $< 10.1\%$ of samples $\geq 3.0 \mu\text{g}/\text{m}^3$	1) and 2) Part 58 App A Sec. 3.2.3 3 Recommendation based on DQO in 40 CFR Part 58 App A Sec. 2.3.1.1
Accuracy			
Temperature Audit	every 180 days and at time of flow rate audit	$< \pm 2.1^\circ\text{C}$	1, 2 and 3) Method 2.12 Sec. 11.2.2
Pressure Audit	every 180 days and at time of flow rate audit	$< \pm 10.1$ mm Hg	1, 2 and 3) Method 2.12 Sec. 11.2.3
<i>Semi Annual Flow Rate Audit</i>	<i>Twice a calendar year and between 5-7 months apart</i>	$< \pm 4.1\%$ of audit standard $< \pm 5.1\%$ of design flow rate	1 and 2) Part 58, App A, Sec. 3.2.2 3) Method 2.12 Sec. 11.2.1
Monitor Maintenance			
PM <sub>2.5</sub> Separator (W/Ns)	every 5 sampling events	cleaned/changed	1, 2, and 3) <a href="#">Method 2.12</a> , Sec. 8.2.2
PM <sub>2.5</sub> Separator (VSCC)	every 30 days	cleaned/changed	1, 2 and 3) Method 2.12 Sec. 8.3.3
Inlet Cleaning	every 30 days	cleaned	1, 2 and 3) Method 2.12 Sec. 8.3
Downtube Cleaning	every 90 days	cleaned	1, 2 and 3) Method 2.12 Sec. 8.4
Filter Housing Assembly Cleaning	every 30 days	cleaned	1, 2 and 3) Method 2.12 Sec. 8.3
Circulating Fan Filter Cleaning	every 30 days	cleaned/changed	1, 2 and 3) Method 2.12 Sec. 8.3
Manufacturer-Recommended Maintenance	per manufacturers' SOP	per manufacturers' SOP	
<b>Laboratory Activities</b>			
Filter Checks			
Lot Blanks	9 filters per lot	$< \pm 15.1 \mu\text{g}$ change between weighings	1, 2, 3) Recommendation and used to determine filter stability of the lot of filters received from EPA or vendor. Method 2.12 Sec. 10.5
Exposure Lot Blanks	3 filters per lot	$< \pm 15.1 \mu\text{g}$ change between weighings	1, 2 and 3) Method 2.12 Sec. 10.5 Used for preparing a subset of filters for equilibration
Filter Integrity (exposed)	each filter	no visual defects	1, 2 and 3) Method 2.12 Sec. 10.7 and 10.3
Lab QC Checks			

Section 4: Discrete PM2.5 and PM10

Revised: February 23, 2023

Revision Number: 9

1) Criteria (PM2.5 LC)	2) Frequency	3) Acceptable Range	Information /Action
<i>Field Filter Blank</i>	10% or 1 per weighing session	<± 30.1 µg change between weighings	1) 40 CFR Part 50, App. L Sec. 8.3.7.1 2 and 3) Method 2.12 Table 7-1 & Sec.10.5
<i>Lab Filter Blank</i>	10% or 1 per weighing session	<± 15.1 µg change between weighings	1) 40 CFR Part 50, App. L Sec. 8.3.7.2 2 and 3) Method 2.12 Sec. 10.5
Balance Check (working standards)	beginning, 10th sample, end	< ±3.1 µg from certified value	1, 2 and 3) Method 2.12 Sec. 10.6 Standards used should meet specifications in Method 2.12, Sec. 4.3.7
Routine Filter re-weighing	1 per weighing session	<± 15.1 µg change between weighings	1, 2 and 3) Method 2.12 Sec. 10.8
Microbalance Audit	every 365 days and once a calendar year	<± 0.003 mg or manufacturers specs, whichever is tighter	1, 2 and 3) Method 2.12 Sec. 11.2.7
Lab Temp Check	Every 90 days	< ± 2.1°C	1, 2 and 3) Method 2.12 Sec. 10.10
Lab Humidity Check	Every 90 days	< ± 2.1%	1, 2 and 3) Method 2.12 Sec. 10.10
<b>Verification/Calibration</b>			
<i>Microbalance Calibration</i>	<i>At installation</i> every 365 days and once a calendar year	Manufacturer's specification	1) 40 CFR Part 50, App. L, Sec. 8.1 2) 40 CFR Part 50, App. L, Sec. 8.1 and Method 2.12 Sec. 10.11 3) NA
Lab Temperature Certification	every 365 days and once a year	< ± 2.1°C	1, 2 and 3) Method 2.12 Sec. 4.3.8 and 9.4
Lab Humidity Certification	every 365 days and once a year	< ± 2.1%	1, 2 and 3) Method 2.12 Sec. 4.3.8 and 9.4
<b>Calibration &amp; Check Standards -</b>			
Working Mass Stds. Verification Compared to primary standards	Every 90 days	< ±2.1 ug	1, 2 and 3) <a href="#">Method 2.12</a> Sec. 9.7
Primary standards certification	every 365 days and once a calendar year	0.025 mg tolerance (Class 2)	1, 2 and 3) Method 2.12 Sec. 4.3.7
<b>SYSTEMATIC CRITERIA -PM<sub>2.5</sub> Filter Based Local Conditions</b>			
<i>Siting</i>	every 365 days and once a calendar year	<i>Meets siting criteria or waiver documented</i>	1) 40 CFR Part 58 App E, Sec. 2-5 2) Recommendation 3) 40 CFR Part 58 App E, Sec. 2-5
<i>Data Completeness</i>	<i>Annual Standard</i> <i>24-Hour Standard</i>	<i>≥ 75% scheduled sampling days in each quarter</i> <i>≥ 75% scheduled sampling days in each quarter</i>	1, 2 and 3) 40 CFR Part 50, App. N, Sec. 4.1 (b) 4.2 (a) 1, 2 and 3) 40 CFR Part 50, App. N, Sec. 4.1 (b) 4.2 (a)
<i>Reporting Units</i>	<i>all filters</i>	<i>µg/m<sup>3</sup> at ambient temp/pressure (PM<sub>2.5</sub>)</i>	1, 2 and 3) 40 CFR Part 50 App N Sec. 3.0 (b)
<i>Rounding convention for design value calculation</i>	<i>all filters</i>	<i>to one decimal place, with additional digits to the right being truncated</i>	1, 2 and 3) 40 CFR Part 50 App N Sec. 3.0 (b) The rounding convention is for averaging values for comparison to NAAQS not for reporting individual values.

Section 4: Discrete PM2.5 and PM10

Revised: February 23, 2023

Revision Number: 9

1) Criteria (PM2.5 LC)	2) Frequency	3) Acceptable Range	Information /Action
<i>Annual 3-yr average</i>	<i>all concentrations</i>	<i>nearest 0.1 µg/m<sup>3</sup> (≥ 0.05 round up)</i>	1, 2 and 3) 40 CFR Part 50, App. N Sec. 3 and 4 Rounding convention for data reported to AQS is a recommendation
<i>24-hour, 3-year average</i>	<i>all concentrations</i>	<i>nearest 1 µg/m<sup>3</sup> (≥ 0.5 round up)</i>	1, 2 and 3) 40 CFR Part 50, App. N Sec. 3 and 4 Rounding convention for data reported to AQS is a recommendation
<b>Detection Limit</b>			
<i>Lower DL</i>	<i>all filters</i>	<i>≤ 2 µg/m<sup>3</sup></i>	1, 2 and 3) 40 CFR Part 50, App. L Sec. 3.1
<i>Upper Conc. Limit</i>	<i>all filters</i>	<i>≥ 200 µg/m<sup>3</sup></i>	1, 2 and 3) 40 CFR Part 50, App. L Sec. 3.2
<b>Precision</b>			
Single analyzer (collocated monitors)	every 90 days	Coefficient of variation (CV) < 10.1% for values ≥ 3.0 µg/m <sup>3</sup>	1, 2 and 3) Recommendation in order to provide early (quarterly) evaluation of achievement of DQOs.
<i>Primary Quality Assurance Org.</i>	<i>Annual and 3 year estimates</i>	<i>90% CL of CV &lt; 10.1 % for values ≥ 3.0 µg/m<sup>3</sup></i>	1, 2 and 3) 40 CFR Part 58, App A, Sec. 4.2.1 and 2.3.1.1
<b>Bias</b>			
<i>Performance Evaluation Program (PEP)</i>	<i>5 audits for PQAOs with ≤ 5 sites</i> <i>8 audits for PQAOs with &gt; 5 sites</i>	<i>&lt; ± 10.1% for values ≥ 3.0 µg/m<sup>3</sup></i>	1, 2 and 3) 40 CFR Part 58, App A, Sec. 3.2.4, 4.2.5 and 2.3.1.1
<b>Field Activities</b>			
<b>Verification/Calibration Standards Recertifications – All standards should have multi-point certifications against NIST Traceable standards</b>			
<i>Flow Rate Transfer Std.</i>	every 365 days and once a calendar year	<i>&lt; ± 2.1% of <u>NIST Traceable Std.</u></i>	1) 40 CFR Part 50, App. L Sec. 9.1 & 9.2 2) Method 2-12 Sec. 4.2.2 & 6.4.3 3) 40 CFR Part 50, App. L Sec. 9.1 & 9.2
Field Thermometer	every 365 days and once a calendar year	± 0.1° C resolution, ± 0.5° C accuracy	1, 2 and 3) Method 2.12 Sec. 4.2.2
Field Barometer	every 365 days and once a calendar year	± 1 mm Hg resolution, ± 5 mm Hg accuracy	1, 2 and 3) Method 2.12 Sec. 4.2.2
Clock/timer Verification	Every 30 days	<i>1 min/mo</i>	1 and 2) Method 2.12 Sec. 4.2.1 3) 40 CFR Part 50, App. L, Sec. 7.4.12
<b>Laboratory Activities</b>			
<i>Microbalance Readability</i>	<i>At purchase</i>	<i>1 µg</i>	1, 2 and 3) 40 CFR Part 50, App. L Sec. 8.1
Microbalance Repeatability	At purchase	1 µg	1) Method 2.12 Sec. 4.3.6 2) Recommendation 3) Method 2.12 Sec. 4.3.6
Primary Mass/Working mass Verification/Calibration Standards	At purchase	0.025 mg tolerance (Class 2)	1, 2 and 3) Method 2.12 Sec. 4.3.7

**Section 4: Discrete PM2.5 and PM10**

Revised: February 23, 2023

Revision Number: 9

1) Criteria (PM2.5 LC)	2) Frequency	3) Acceptable Range	Information /Action
<b>Comment #1</b> The associated leak test procedure shall require that for successful passage of this test, the difference between the two pressure measurements shall not be greater than the number of mm of Hg specified for the sampler by the manufacturer, based on the actual internal volume of the sampler, that indicates a leak of less than 80 mL/min.			

$\downarrow$  value must be flagged SD \* = standard deviation CV= coefficient of variation

NOTE: Polk County Air Quality's SOP may specify more stringent requirements for non-critical criteria or more frequent QA procedures than required by the EPA. The operational and systematic criteria listed in the MQO Table are the Federal minimum criteria only.

**APPENDIX A-Critical Forms and Field Sheets**

**Form 1.....PM2.5 Audit Field Sheet**  
**Form 2.....PM10 Audit Field Sheet**  
**Form 3.....PM2.5 Annual Calibration Field Sheet**  
**Form 4..... PM2.5 Verification Field Sheet**  
**Form 5.....PM10 Annual Calibration Field Sheet**  
**Form 6.....PM10 Verification Field Sheet**  
**Form 7.....Corrective Action Form**

Section 4: Discrete PM2.5 and PM10

Revised: February 23, 2023

Revision Number: 9

Form 1: PM2.5 Audit Field Sheet

PM2.5 QUARTERLY AUDIT

Site Name: \_\_\_\_\_

Date: \_\_\_\_\_

Site Location: \_\_\_\_\_

Time: \_\_\_\_\_

Technician's Name: \_\_\_\_\_

Sampler ID: \_\_\_\_\_

Observer's Name: \_\_\_\_\_

Sampler Model: 2025

**1) TEMPERATURE (T) VERIFICATION**

	Sampler	Actual	
Amb. Temp. (°C)			≤2 °C difference
Filter Comp Temp. (°C)			≤4 °C difference
Filter Temp. (°C)			≤2 °C difference

Note: Perform an investigation if the sampler and actual temperatures are not within the limits set in that specified row.

**2) PRESSURE (P) VERIFICATION**

	Sampler	Actual	
Amb. Pressure (mmHg)			≤10 mmHg difference

Note: Perform an investigation if the sampler and actual pressures are not within 10 mmHg difference.

**LEAK CHECKS:**

3) External	Pass or Fail ≤25 mmHg/min	Indicated mmHg/min
Leak Check		
2nd Attempt		
5) Internal	Pass or Fail ≤140 mmHg/min	Indicated mmHg/min
Leak Check		
2nd Attempt		

Note: Perform a second attempt if initial leak check fails to meet the criteria specified in the Pass or Fail column.

**4) FLOW RATE CHECK:**

Set Point (l/min)	16.70
"Sampler" Flow (l/min)	
"Actual Flow"	
(Sampler - Actual)/Actual x 100 =	% ≤4%
(Actual - 16.7)/16.7 x 100 =	% ≤5%
Sampler Flow with PM 10 Inlet installed	
(Sampler - 16.7)/16.7 x 100 =	% ≤2%

Note: Perform an investigation if the percent difference is greater than that specified in its' row.

	Manufacturer	Model	Serial Number	Recertification Date
Temperature Reference	Oakton	Temp 10 T		
Pressure Reference	CE	Handheld		
Flow Standard	Chinook/Dwyer	Series 475/ Mark III		

Comments: \_\_\_\_\_  
 \_\_\_\_\_  
 \_\_\_\_\_  
 \_\_\_\_\_  
 \_\_\_\_\_

Section 4: Discrete PM2.5 and PM10

Revised: February 23, 2023

Revision Number: 9

Form 2: PM10 Audit Field Sheet

PM10 QUARTERLY AUDIT

Site Name: \_\_\_\_\_

Date: \_\_\_\_\_

Site Location: \_\_\_\_\_

Time: \_\_\_\_\_

Technician's Name: \_\_\_\_\_

Sampler ID: \_\_\_\_\_

Observer's Name: \_\_\_\_\_

Sampler Model: 2025

**1) TEMPERATURE (T) VERIFICATION**

	Sampler	Actual	
Amb. Temp. (°C)			≤2 °C difference
Filter Comp Temp. (°C)			≤4 °C difference
Filter Temp. (°C)			≤2 °C difference

Note: Perform an investigation if the sampler and actual temperatures are not within the limits set in that specified row.

**2) PRESSURE (P) VERIFICATION**

	Sampler	Actual	
Amb. Pressure (mmHg)			≤10 mmHg difference

Note: Perform an investigation if the sampler and actual pressures are not within 10 mmHg difference.

**LEAK CHECKS:**

3) External	Pass or Fail ≤25 mmHg/min	Indicated mmHg/min
Leak Check		
2nd Attempt		
5) Internal	Pass or Fail ≤140 mmHg/min	Indicated mmHg/min
Leak Check		
2nd Attempt		

Note: Perform a second attempt if initial leak check fails to meet the criteria specified in the Pass or Fail column.

**4) FLOW RATE CHECK:**

Set Point (l/min)	16.70
"Sampler" Flow (l/min)	
"Actual Flow"	
(Sampler - Actual)/Actual x 100 =	% ≤4%
(Actual - 16.7)/16.7 x 100 =	% ≤5%
Sampler Flow with PM 10 Inlet installed	
(Sampler - 16.7)/16.7 x 100 =	% ≤2%

Note: Perform an investigation if the percent difference is greater than that specified in its' row.

	Manufacturer	Model	Serial Number	Recertification Date
Temperature Reference	Oakton	Temp 10 T		
Pressure Reference	CE	Handheld		
Flow Standard	Chinook/Dwyer	Series 475/ Mark III		

Comments: \_\_\_\_\_

\_\_\_\_\_

\_\_\_\_\_

\_\_\_\_\_

\_\_\_\_\_

Section 4: Discrete PM2.5 and PM10

Revised: February 23, 2023

Revision Number: 9

Form 3: PM2.5 Annual Calibration Sheet

PM2.5 ANNUAL CALIBRATION

Site Name: \_\_\_\_\_

Date: \_\_\_\_\_

Site Location: \_\_\_\_\_

Time: \_\_\_\_\_

Technician's Name: \_\_\_\_\_

Sampler ID: \_\_\_\_\_

Observer's Name: \_\_\_\_\_

Sampler Model: 2025i

**FLOW RATE CALIBRATION:**

	Sampler flow (l/min)	Actual flow (l/min)	in H <sub>2</sub> O
15.0			
16.7			
18.4			
Average			

$(\text{Sampler Avg} - \text{Actual Average}) / \text{Actual Avg} \times 100$  %

Sampler Post-Cal Flow		
Set Point (l/min)	16.70	
Actual Flow (l/min)		
$(\text{Sampler} - \text{Actual}) / \text{Actual} \times 100$	%	≤2%
$(\text{Actual} - 16.7) / 16.7 \times 100$	%	<5%
Sampler Flow w/inlet installed		
$(\text{Sampler} - 16.7) / 16.7 \times 100$	%	≤2%

Note: When performing any calibration, the sampler and the standard must fall within the specified limitations noted next to each test. If not a re-calibration will be performed.

Comments:

**TEMPERATURE CALIBRATION:**

	Cold		Ambient		Hot	
	Sampler Indicated	Standard Actual	Sampler Indicated	Standard Actual	Sampler Indicated	Standard Actual
1)						
2)						
3)						
4)						
5)						
Avg.						

Ambient Temperature

Sampler Avg - Actual Avg = ±2°C

	Cold		Ambient		Hot	
	Sampler Indicated	Standard Actual	Sampler Indicated	Standard Actual	Sampler Indicated	Standard Actual
1)						
2)						
3)						
4)						
5)						
Avg.						

Filter Temperature

Sampler Avg - Actual Avg = ±2°C



**Section 4: Discrete PM2.5 and PM10**

Revised: February 23, 2023

Revision Number: 9

	Sampler Indicated	Standard Actual	
Filter Compartment Temperature			+2°C

PRESSURE CALIBRATION:			
Ambient Pressure	Sampler Pressure (mmHg)	Actual Pressure (mmHg)	
Sampler - Actual =			<10 mmHg
Filter Pressure	Sampler Pressure (mmHg)	Actual Pressure (mmHg)	
Sampler - Actual =			<10 mmHg

LEAK CHECKS:			
External	Indicated mmHg/min	Pass or Fail	
Leak Check			<25 mmHg/min
2nd Attempt			
Internal	Indicated mmHg/min	Pass or Fail	
Leak Check			<140mmHg/min
2nd Attempt			

Note: Perform a second attempt if initial leak check fails to meet the criteria specified in the Pass or Fail column.

Has the sampler been set to sample in local conditions?	Yes or No
Has the VSCC been installed?	Yes or No
Is time and date correct?	Yes or No

	Manufacturer	Model	Serial Number	Recertification Date
Temperature Reference	Traceable	37803-92		
Pressure Reference	Digi-Sense	18000-33		
Flow Standard	Dwyer/Chinook	Series 475/ Mark III		

Section 4: Discrete PM2.5 and PM10

Revised: February 23, 2023

Revision Number: 9

Form 4: PM2.5 Verification Field Sheet

PM2.5 MONTHLY VERIFICATION

Site Name: \_\_\_\_\_  
 Site Location: Des Moines  
 Technician's Name: \_\_\_\_\_  
 Observer's Name: \_\_\_\_\_

Date: \_\_\_\_\_  
 Time: \_\_\_\_\_  
 Sampler ID: \_\_\_\_\_  
 Sampler Model: 2025

**1) TEMPERATURE (T) VERIFICATION**

	Sampler	Actual	
Amb. Temp. (°C)			≤2 °C difference
Filter Comp Temp. (°C)			≤4 °C difference
Filter Temp. (°C)			≤2 °C difference
Note: Perform an investigation if the sampler and actual temperatures are not within the limits set in that specified row. Calibrate if necessary			

**2) PRESSURE (P) VERIFICATION**

	Sampler	Actual	
Amb. Pressure (mmHg)			≤10 mmHg difference
Note: Perform an investigation if the sampler and actual pressures are not within 7 mmHg difference. Calibrate if necessary			

**LEAK CHECKS:**

3) External		
	Pass or Fail ≤25 mmHg/min	Indicated mmHg/min
Leak Check		
2nd Attempt		
5) Internal		
	Pass or Fail ≤140 mmHg/min	Indicated mmHg/min
Leak Check		
2nd Attempt		
Note: Perform a second attempt if initial leak check fails to meet the criteria specified in the Pass or Fail column.		

**4) FLOW RATE CHECK:**

Set Point (l/min)	16.70	
"Sampler" Flow (l/min)		
"Actual Flow"		
(Sampler - Actual)/Actual x 100 =	%	≤4%
(Actual - 16.7)/16.7 x 100 =	%	≤5%
Sampler Flow with PM 10 Inlet installed		
(Sampler - 16.7)/16.7 x 100 =	%	≤2%
Note: Perform an investigation if the percent difference is greater than that specified in its' row. Calibrate if necessary		

	Manufacturer	Model	Serial Number	Recertification Date
Temperature Reference				
Pressure Reference				
Flow Standard				

	Yes or No
Cleaned VSCC (Monthly)	
Cleaned Circulating Fan Filters (every month)	
Cleaned Filter Compartment (every month):	
Clean PM10 inlet (15 events/monthly):	

Comments: \_\_\_\_\_  
 \_\_\_\_\_  
 \_\_\_\_\_

Date of Last Calibration: \_\_\_\_\_

Section 4: Discrete PM2.5 and PM10

Revised: February 23, 2023

Revision Number: 9

Form 5: PM10 Annual Calibration Sheet

PM10 ANNUAL CALIBRATION

Site Name: \_\_\_\_\_

Date: \_\_\_\_\_

Site Location: \_\_\_\_\_

Time: \_\_\_\_\_

Technician's Name: \_\_\_\_\_

Sampler ID: \_\_\_\_\_

Observer's Name: \_\_\_\_\_

Sampler Model: 2025i

**FLOW RATE CALIBRATION:**

_____		
	<b>Sampler flow (l/min)</b>	<b>Actual flow (l/min)</b>
	<b>in H<sub>2</sub>O</b>	
15.0		
16.7		
18.4		
<b>Average</b>		
$(\text{Sampler Avg} - \text{Actual Average}) / \text{Actual Avg} \times 100$		%
<b>Sampler Post-Cal Flow</b>	_____	
<b>Set Point (l/min)</b>	16.70	
<b>Actual Flow (l/min)</b>	_____	
$(\text{Sampler} - \text{Actual}) / \text{Actual} \times 100$	%	$\leq 2\%$
$(\text{Actual} - 16.7) / 16.7 \times 100$	%	$< 5\%$
<b>Sampler Flow w/inlet installed</b>	_____	
$(\text{Sampler} - 16.7) / 16.7 \times 100$	%	$\leq 2\%$

Note: When performing any calibration, the sampler and the standard must fall within the specified limitations noted next to each test. If not a re-calibration will be performed.

Comments:

**TEMPERATURE CALIBRATION:**

Ambient Temperature		<b>Cold</b>		<b>Ambient</b>		<b>Hot</b>	
		Sampler Indicated	Standard Actual	Sampler Indicated	Standard Actual	Sampler Indicated	Standard Actual
		1)					
		2)					
		3)					
		4)					
		5)					
	<b>Avg.</b>						
<b>Sampler Avg - Actual Avg =</b>				<b><math>\pm 2^\circ\text{C}</math></b>			
Filter Temperature		<b>Cold</b>		<b>Ambient</b>		<b>Hot</b>	
		Sampler Indicated	Standard Actual	Sampler Indicated	Standard Actual	Sampler Indicated	Standard Actual
		1)					
		2)					
		3)					
		4)					
		5)					
	<b>Avg.</b>						
<b>Sampler Avg - Actual Avg =</b>				<b><math>\pm 2^\circ\text{C}</math></b>			

Sampler Pre-Cal Flow

**Section 4: Discrete PM2.5 and PM10**

Revised: February 23, 2023

Revision Number: 9

	Sampler Indicated	Standard Actual	
Filter Compartment Temperature			±2'C

PRESSURE CALIBRATION:			
Ambient Pressure	Sampler Pressure (mmHg)	Actual Pressure (mmHg)	
Sampler - Actual =			≤10 mmHg
Filter Pressure	Sampler Pressure (mmHg)	Actual Pressure (mmHg)	
Sampler - Actual =			≤10 mmHg

LEAK CHECKS:			
External	Indicated mmHg/min	Pass or Fail	
Leak Check			<25 mmHg/min
2nd Attempt			
Internal	Indicated mmHg/min	Pass or Fail	
Leak Check			<140 mmHg/min
2nd Attempt			

Note: Perform a second attempt if initial leak check fails to meet the criteria specified in the Pass or Fail column.

Has the sampler been set to sample in standard conditions? Yes or No

Has the PM10 downtube been installed? Yes or No

Is time and date correct? Yes or No

	Manufacturer	Model	Serial Number	Recertification Date
Temperature Reference	Traceable	37803-92		
Pressure Reference	Digi-Sense	18000-33		
Flow Standard	Dwyer/Chinook	Series 475/ Mark III		

Section 4: Discrete PM2.5 and PM10

Revised: February 23, 2023

Revision Number: 9

Form 6: PM10 Verification Field Sheet

PM10 MONTHLY VERIFICATION

Site Name: \_\_\_\_\_  
 Site Location: Des Moines  
 Technician's Name: \_\_\_\_\_  
 Observer's Name: \_\_\_\_\_

Date: \_\_\_\_\_  
 Time: \_\_\_\_\_  
 Sampler ID: \_\_\_\_\_  
 Sampler Model: 2025

1) TEMPERATURE (T) VERIFICATION			
	Sampler	Actual	
Amb. Temp. (°C)			≤2 °C difference
Filter Comp Temp. (°C)			≤4 °C difference
Filter Temp. (°C)			≤2 °C difference
Note: Perform an investigation if the sampler and actual temperatures are not within the limits set in that specified row. Calibrate if necessary			

2) PRESSURE (P) VERIFICATION			
	Sampler	Actual	
Amb. Pressure (mmHg)			≤10 mmHg difference
Note: Perform an investigation if the actual and sampler pressures are not within 7 mmHg difference. Calibrate if Necessary			

LEAK CHECKS:		
<b>3) External</b>	Pass or Fail ≤25 mmHg/min	Indicated mmHg/min
Leak Check		
2nd Attempt		
<b>5) Internal</b>	Pass or Fail ≤140 mmHg/min	Indicated mmHg/min
Leak Check		
2nd Attempt		
Note: Perform a second attempt if initial leak check fails to meet the criteria specified in the Pass or Fail column.		

4) FLOW RATE CHECK:			
Set Point (l/min)	16.70		
"Sampler" Flow (l/min)			
"Actual Flow"			
(Sampler - Actual)/Actual x 100 =	%	≤4%	
(Actual - 16.7)/16.7 x 100 =	%	≤5%	
Sampler Flow with PM 10 Inlet installed			
(Sampler - 16.7)/16.7 x 100 =	%	≤2%	
Note: Perform an investigation if the percent difference is greater than that specified in its' row. Calibrate if necessary			

	Manufacturer	Model	Serial Number	Recertification Date
Temperature Reference				
Pressure Reference				
Flow Standard				

	Yes or No
Cleaned Circulating Fan Filter (monthly):	
Cleaned Filter Compartment (monthly):	
Cleaned PM10 inlet/downtube (15 events/mo):	

Comments: \_\_\_\_\_  
 \_\_\_\_\_  
 \_\_\_\_\_  
 \_\_\_\_\_  
 Date of Last Calibration: \_\_\_\_\_

**Form 7: Corrective Action Form**

**Polk County Air Quality - Corrective Action Form**

To: \_\_\_\_\_ Polk County Air Quality \_\_\_\_\_  
(position)

From: \_\_\_\_\_

Copies of completed form to: AQ Supervisor, File

Urgency:  Emergency (immediate action needed)  Urgent (24 Hr.)  
 Routine (7 days)  Next scheduled visit  Information only

**Problem Identification:**

Site: \_\_\_\_\_  
System: \_\_\_\_\_  
Date: \_\_\_\_\_

Description of Problem: \_\_\_\_\_  
\_\_\_\_\_  
\_\_\_\_\_  
\_\_\_\_\_

Recommended Action: \_\_\_\_\_  
\_\_\_\_\_  
\_\_\_\_\_

Signature of Initiator: \_\_\_\_\_ Date: \_\_\_\_\_

**Problem Resolution:**

Date of Corrective Action: \_\_\_\_\_

Summary of Corrective Action: \_\_\_\_\_  
\_\_\_\_\_  
\_\_\_\_\_  
\_\_\_\_\_

Result of Corrective Action: \_\_\_\_\_  
\_\_\_\_\_  
\_\_\_\_\_  
\_\_\_\_\_

Signature of Resolver: \_\_\_\_\_ Date: \_\_\_\_\_

Signature of QA Officer: \_\_\_\_\_ Date: \_\_\_\_\_

**Send copy of completed form to initiator.**

